



USER MANUAL

© 2022 **Life Assistant LTD**

Manual identification: LAPLAB.000.030-R0-Eng, May 2022

© 2022 **Life Assistant** Ltd, all rights reserved. No part of this manual may be reproduced in any form without the written permission of **Life Assistant** Ltd.

Life Assistant Ltd. reserves the right to change or improve its products and accompanying technical literature without specific notice to changes or improvements.



Manufacturer

Life Assistant LTD,

8 Harod St.Afula, 1871208, ISRAEL

email info@sitnstand.com

web www.lifeassistant.com



Authorized Representative in the EU:

Advena Ltd.

Malta Office
Tower Business Centre, 2nd Flr,
Tower Street, Swatar,
BKR 4013, Malta

UK Office
Pure Offices, Plato Close,
Tachbrook Park, Warwick,
CV34 6WE, UK

TABLE OF CONTENTS

INTRODUCTION.....	6
About This Manual.....	7
Life Assistant Sitnstand Product Overview.....	7
Contents.....	8
Special messages: Warnings, Cautions and Notes.....	8
Conditions for Use.....	9
SAFETY.....	10
General Warnings and Cautions.....	11
LABELS AND SYMBOLS.....	12
USING THE SITNSTAND FOR WHEELCHAIRS.....	14
Setup Instructions.....	15
Following the Appropriate Seat Selection.....	17
Controller Indicator Modes.....	19
Sitting Down.....	20
Standing Up.....	20
Replacing the Battery.....	22
Charging the Battery.....	23
MAINTENANCE.....	24
TROUBLESHOOTING.....	26
Basic Troubleshooting.....	27
To Obtain Information.....	28
OPERATING SPECIFICATIONS.....	30
1.1 Environmental.....	31
1.2. Electrical.....	32
1.3. Physical and Operational.....	33
LIMITED WARRANTY.....	34
EMC STATEMENT.....	36
Warnings.....	36
Electromagnetic Emissions.....	38

INTRODUCTION

ABOUT THIS MANUAL

This manual provides the information necessary to operate **Life Assistant SitnStand for Wheelchairs** in a safe and efficient manner. Please review and understand this manual before operating the system. If any part of this manual is unclear, contact your supplier or **Life Assistant** Customer Support for clarification.

Life Assistant Sitnstand for Wheelchairs Product Overview

The SitnStand For Wheelchairs – Portable Smart Rising Seat is a lightweight, portable inflatable system for wheelchairs that is safe, simple and easy to operate. It comprises an electronic control system, multiple air valves, multiple air sealed layers, and a portable air pump that supplies the required pressure and air capacity to assist standing up and sitting down with minimum or no help required.

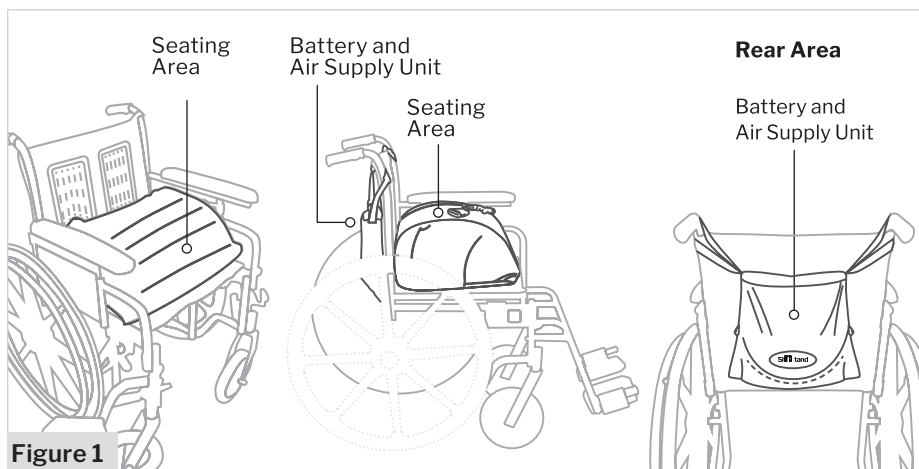

Contents

- 1 *SitnStand For Wheelchairs* unit
- 1 Visco / memory foam cushion
- 1 Li-Ion 14.4VDC rechargeable battery
- 1 Wall battery charger with 1m cable and connector
- 1 User manual

Warnings, Cautions and Notes

Three types of special messages appear in this User Manual:



WARNING indicates the possibility of injury to the patient or operator.



CAUTION indicates a condition that may lead to equipment malfunction.



NOTE provides other important information.

Conditions for Use

INTENDED USE

The **SitnStand for Wheelchairs** is a powered inflatable cushion to intended to assist patients suffering from mobility difficulties to rise from a seated position to standing position, as well as to sit down from a standing position.

The **SitnStand for Wheelchairs** is intended to be used in the homecare environment while performing daily activities, as well as in medical care facilities.

INTENDED USERS

The **SitnStand for Wheelchairs** is intended for the home care environment, to be used by elderly people and/or people with compromised mobility or difficulties that require the use of a wheelchair. The **SitnStand for Wheelchairs** is intended to be used by people with chronic or acute mobility difficulty who use a wheelchair.

The **SitnStand for Wheelchairs** is intended to be used by cognitive impairment patients who sit on a wheelchair while assisted by a caretaker. They should familiarize themselves with the instructions in this manual.

CONTRA-INDICATIONS

- Do not use the **SitnStand for Wheelchairs** while under the influence of narcotics or alcohol.
- Do not use the **SitnStand for Wheelchairs** while holding a child or infant.
- Do not use the **SitnStand for Wheelchairs** inside a vehicle.
- Do not use the **SitnStand for Wheelchairs** when undressed.
- In the case of Cognitive impairment, use the **SitnStand for Wheelchairs** only with a caregiver.

SAFETY

General Warnings and Cautions



WARNING: DO NOT USE PRIOR TO READING AND UNDERSTANDING THIS MANUAL.



WARNING: To avoid the potential for electrical shock, use only the designated charger provided with the device. Using any other charger may cause an electrical and/or electromagnetic hazard.



WARNING: Do not move the wheelchair until the cushion is fully diflated



WARNING: To avoid the potential for electric shock, the power supply must be disconnected from the power mains prior to cleaning.



WARNING: To avoid the potential for electric shock, contact your supplier or **Life Assistant Ltd.** when a malfunction occurs.



WARNING: Do not inflate under the bottom of a table or other item that interferes with the cushion inflation.



NOTE: The only user-serviceable components in the system is the battery.



CAUTION: Changes or modifications not expressly approved by **Life Assistant Ltd** can affect the safety and effectiveness of the system, and will invalidate the system's warranty.













CAUTION: Do not operate with damaged cords or plugs. If damaged, please contact the company.



CAUTION: At the end of its useful life, the system and battery must be disposed of in accordance with local law and/or code concerning electrical and electronic equipment.

LABELS AND SYMBOLS

SYMBOL	DESCRIPTION
	Consult Instructions For Use
	Date of Manufacture
	Special Requirements for Disposal of Electrical and Electronic Equipment (WEEE Directive)
	Manufacturer
	Type B Applied Part
	Catalog Number
	Serial Number
	Keep Dry
	Caution
	Information
	Compliance with Medical Device Regulation (EU) 2017/745 Compliance with Medical Device Directive (EU) 93/42/EEC

USING THE SITNSTAND FOR WHEELCHAIRS

Setup Instructions

Setting up the **SitnStand For Wheelchairs** is performed by the user.

The setting up process consists of three steps:

- A. Charging the battery for the first time
- B. Placing the **SitnStand For Wheelchairs** on a wheelchair
- C. Connecting the battery

A – CHARGING THE BATTERY FOR THE FIRST TIME-FIGURE 2

Charge the battery for at least 12 hours before use:

1. Remove the battery from the box
2. Plug in the battery charger into an electric wall socket
3. Connect the battery charger connector to the battery charging socket
4. When the green light is on, battery is fully charged
5. When red light is on, battery is not fully charged



NOTE: To prevent falling over any tangled cable, place the battery close to the charger.

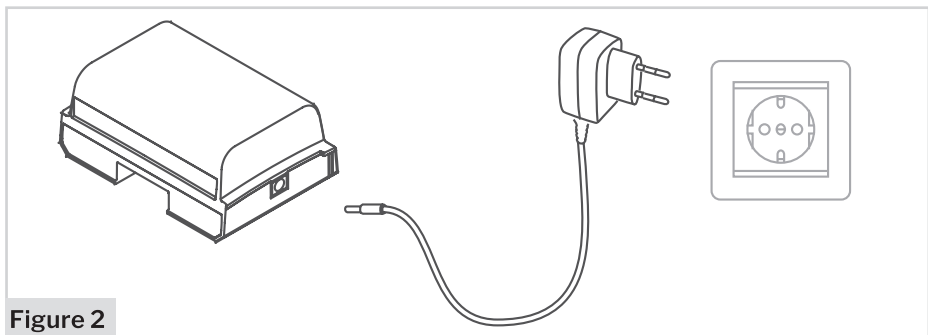

Figure 2

B – PLACING THE SITNSTAND FOR WHEELCHAIRS ON A SUITABLE SEAT – FIGURE 3

*PRIOR TO PLACING THE SITNSTAND FOR WHEELCHAIRS, MAKE SURE THAT THE WHEELCHAIR BRAKES ARE LOCKED

A. Place the **SitnStand for Wheelchairs** folded on the wheelchair - **Figure 3**.

B. Insert the back part / Air Supply unit in the space between the back and the seat of the wheelchair - **Figure 4**.

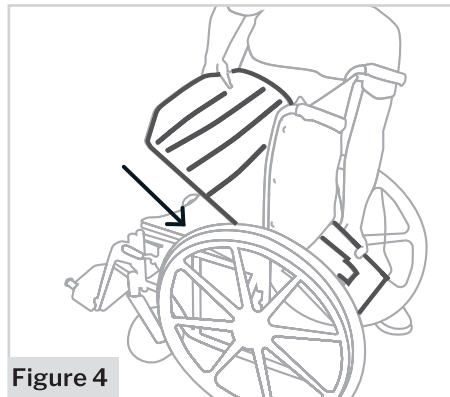
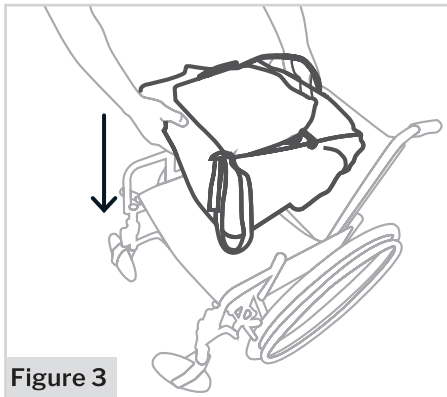

- C. Place the air supply unit's straps on the wheelchair's handles and tighten them up - **figure 5**.
- D. When not in use we recommend you attach the remote control to a velcro strip that will be attached to the wheelchair side handles - Illustrations - **figure 6+7**.

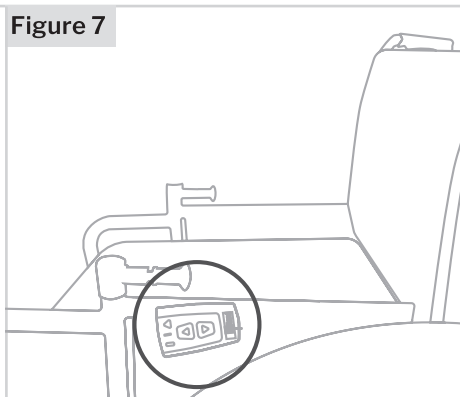
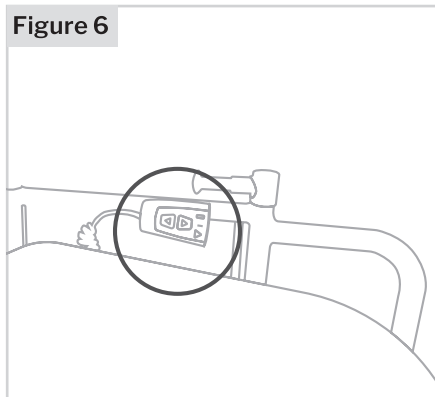
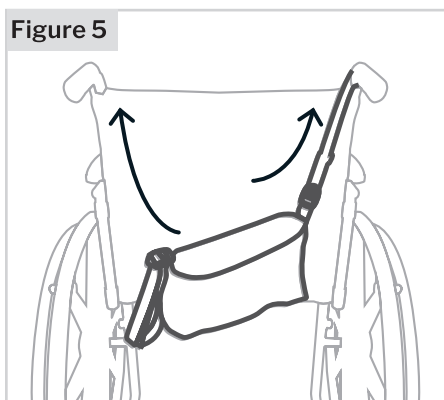

C – INSERTING THE BATTERY IN ITS PLACE – FIGURE 8

Slide the charged battery into its place within the air supply unit, as illustrated in **Figure 8**.

The **SitnStand for Wheelchairs** is now in standby mode, and is ready for use.

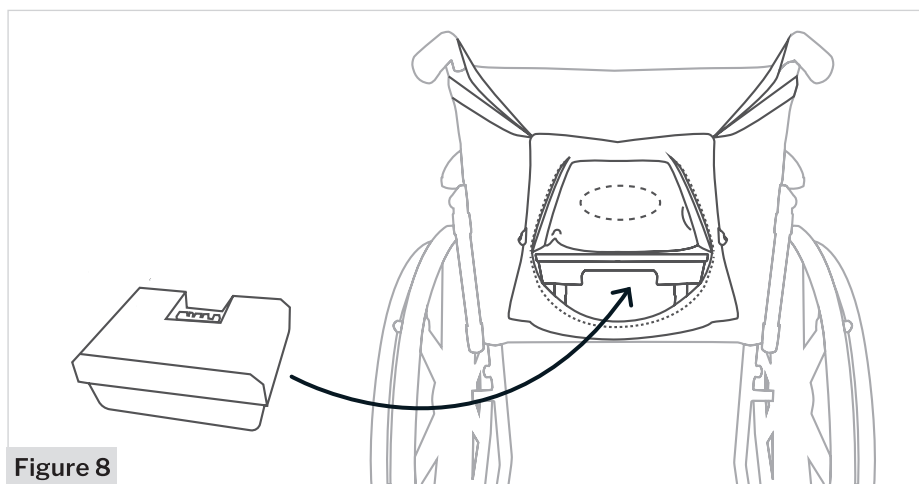

Figure 8

Controller Indicator Modes - Figure 9

1. **Standby Mode** – the Green light flashes slowly (about one flash per second) – the **SitnStand for Wheelchairs** is now ready for use and is waiting for your action.
2. **Working Mode** – the Green light flashes quickly (about 5 times a second) – the **SitnStand for Wheelchairs** is operating (while in this mode, the buttons will not respond).
3. **Charge Battery** – the Orange light is on while the Standby/Working mode green light is also flashing as described in 1 or 2 above – indicating that the battery needs recharging.
4. **Charge Battery** – the Orange light is on and Standby/Working mode Green light is off – battery is depleted. In this case, the **SitnStand for Wheelchairs** cushion can only be deflated.
5. **Error** – the Red and Green lights flash quickly – the **SitnStand for Wheelchairs** has identified a system fault – See troubleshooting chapter.

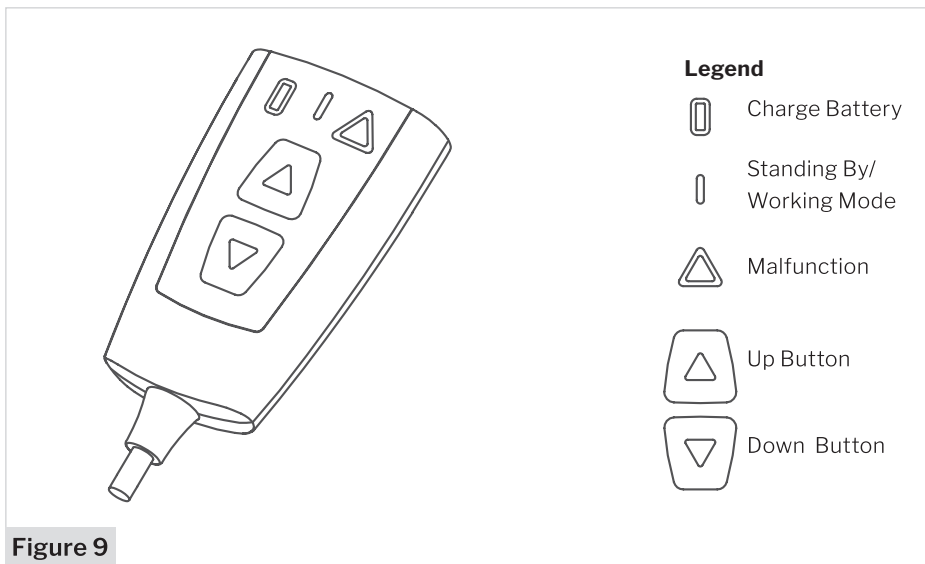

Figure 9

Sitting Down

*PRIOR TO SITTING DOWN, MAKE SURE THAT THE WHEELCHAIR BRAKES ARE LOCKED

1. Inflate the cushion using the controller to 1,2, 3 or 4 layers (whichever is most comfortable for you)
2. Sit comfortably in the center.
3. When you feel steady, start deflating the cushion by pressing on the Down Arrow button on the controller.
4. You can now sit down comfortably

Standing Up

*PRIOR TO STANDING UP MAKE SURE THAT THE WHEELCHAIR BRAKES ARE LOCKED

1. Place your feet on the floor, close to the chair.
2. Sit upright.
3. Spread your feet.
4. Inflate the cushion by pressing the “Up” button.
5. Now you can easily stand Up.



NOTE: In case of cognitive impediment ***the SitnStand for Wheelchairs*** should only be operated by a caregiver.

The ***SitnStand for Wheelchairs*** has 3 layers: however, Inflation can be ended at any time when the level of elevation is sufficient.

Do not attempt to stand up before the layer is totally inflated and there is no sound from the air pump.

The ***SitnStand for Wheelchairs*** may remain inflated until the next time it is used to sit down.

Replacing the Battery – Figure 10

When the Charge Battery indicator turns Orange, battery should be charged.

Open the zipper covering the air supply unit and remove battery by sliding it towards you as illustrated in **Figure 10**.

The battery is connected by a magnet to the air supply unit.



NOTE: Don't remove the battery while the **SitnStand for Wheelchairs** is in "Working Mode" (see controller indicator modes)

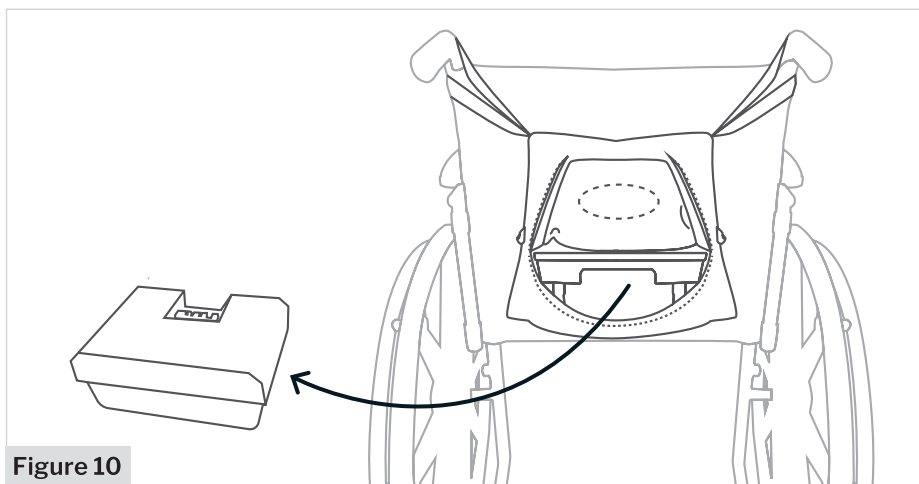

Figure 10

Charging the Battery- Figure 7

1. Plug the battery charger into an electric wall socket.
2. Connect the battery charger connector to the battery charging socket.
3. When the Red light on the charger changes to Green, the battery is fully charged.
4. When the Red light is on, the battery is not fully charged.

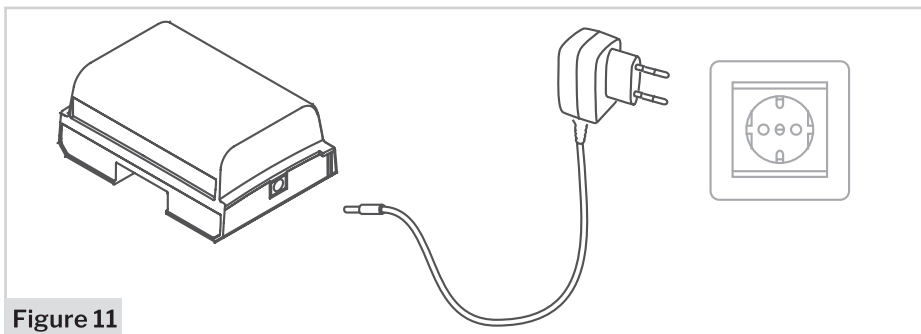

Figure 11

MAINTENANCE

In order to maintain the **SitnStand for Wheelchairs** system, please note the following:

1. Keep the **SitnStand for Wheelchairs** away from dust or dirt.
2. Use a soft dry brush to clean the fabric surfaces (e.g. seat area).
3. Do not iron the textile.
4. Use a damp cloth to clean the plastic surfaces (e.g. air supply unit)
5. Do not use solvents or detergents to clean any part
6. Do not allow liquids near the system openings
7. Keep dry



WARNING: To avoid potential for electrical shock, the power supply must be disconnected from the power mains prior to cleaning.



WARNING: To avoid the potential for electric shock, contact your supplier or **Life Assistant Ltd.** when a malfunction occurs.



NOTE: The only user-serviceable component in the system is the battery.



NOTE: No portion of the system should be immersed in water or other fluids.



NOTE: Never spray or otherwise apply any cleaner fluid directly into the openings or seams of the system. Always apply the cleaner fluid to the cloth instead.

TROUBLESHOOTING

Before addressing the troubleshooting table, please check and confirm the following:

1. The battery is attached to the **SitnStand For Wheelchairs**
2. The battery is charged. (low battery indicator is Off, standby/ready indicator is On)

Basic Troubleshooting

When addressing a malfunction, as an initial action please follow **STEP 1** described in the table below. In case of unsolved malfunction follow **STEP 2**.

MALFUNCTION	STEP 1	STEP 2
Battery not charging	Charge the battery	Contact your supplier or Life Assistant Ltd.
No light on the controller		
Product is not working when pressing the controller		
Does not deflate		
Does not inflate		
Air leaking	Contact your supplier or Life Assistant Ltd.	
Red triangle light and the Green light on the controller are flashing	Press the two remote control buttons (up and down arrows) simultaneously for 10 seconds to reset system	Contact your supplier or Life Assistant Ltd.

To Obtain Information:

Life Assistant Ltd.

8 Harod St. Afula, 1871208, ISRAEL

email: info@sitnstand.com

web: www.sitnstand.com

OPERATING SPECIFICATIONS



NOTE: Unless otherwise indicated, all specifications are subject to change without notice. Specifications and test methods will be made available upon request.

1.1. Environmental

1.1.1. TRANSPORT AND STORAGE ENVIRONMENT

Temperature range: -25°C to +70°C | -13°F to 158°F

Relative humidity range: Without relative humidity – 93%

1.1.2. OPERATION ENVIRONMENTAL CONDITIONS

Temperature range: +5°C to +40°C | 41°F to 104°F

Relative humidity range: 15% to 93%, with no condensation

Atmospheric pressure: 700 – 1060 hPa | 10.15 - 15.37 psi

Transport altitude: 0-2000 meters | 0 - 6562 Feet

1.2. Electrical

Battery type: Lithium-Ion rechargeable, 14.4 V, 2.6 Ah

Operation Voltage: DC 14.4V @ 10A

Charger Input: 100 to 240VAC

Charger output: 16VDC, 0.5A (8W)

Frequency: 50 – 60Hz

Battery life: ~500 charging cycles / one year under warranty that the battery should be over 80% of its capacity



CAUTION: At the end of its useful life, the system and battery must be disposed of in accordance with local law and/or code concerning electrical and electronic equipment. Do not discard to standard trash bin.

1.3. Physical and Operational

Seat footprint – Deflated: 40 x 53 x 5 cm | 16 x 21 x 2 Inch

Seat footprint – Inflated: 40 x 48 x 25 cm | 16 x 19 x 10 Inch

Product Weight: 3.2 kg | 7.0 Lbs.

Max supported weight: 120kg | 264 Lbs.

Nominal Operation time (inflate/deflate): ~25 sec

Control mechanism: Up / down pushbutton ↑↓
Green LED: system ready.
Yellow LED: low bat.
Red LED: Error.

Air capacity: ~1.7 L/Sec @ 1 AT pressure (~60 CFM @ 14 psi)

Device lifetime: ~10000 inflating cycles

LIMITED WARRANTY

Life Assistant Ltd. warrants this product for a period of two years from the date of purchase.

The warranty covers defects in materials and workmanship, comprising the system, assemblies, components and labor, but excluding battery and textile/fabric.

Life Assistant Ltd. warrants the battery and the textile/fabric for one year from the date of purchase. The warranty covers defects in materials and workmanship comprising the system, assemblies, components and labor.

The warranty is not valid in the case of abnormal wear and tear, willful damage, neglect, misuse or unauthorized repair or alteration of the product, or any of its parts or accessories.

The following statements do not affect the consumer's statutory rights. This product is sold on the understanding that, in the event of any defect of manufacture or material appearing within two years of the date of receipt of this product, the defect will be corrected free of charge on condition that evidence of date of ownership is provided. Such evidence may be an invoice, delivery note, etc. and, evidence that the defect is not attributable to accidental damage either in transit or otherwise, misuse or unauthorized repair or alteration.

Product Serial Number: _____

Battery Serial Number: _____

Location of Purchase: _____

Date of Purchase: _____

Delivery Note/Invoice No.: _____

EMC STATEMENT

Warnings



WARNING: Use of this equipment adjacent to or stacked with other equipment should be avoided as it may result in improper operation. If such use is necessary, this equipment and the other equipment should be observed to verify that they are operating normally.



WARNING: Use of accessories, transducers and cables other than those specified or provided by the manufacturer of this equipment, may result in increased electromagnetic emissions or decreased electromagnetic immunity of this equipment, resulting in improper operation.



WARNING: Portable RF communications equipment (including peripherals such as antenna cables and external antennas) should be used no closer than 30 cm (12 inches) to any part of the **SitnStand for Wheelchairs**, including cables specified by the manufacturer. Otherwise, degradation of the performance of this equipment may result.

Electromagnetic Emissions

SitnStand for Wheelchairs is intended for use in the electromagnetic environment specified in the following tables. This is not a life-sustaining device.

The user and/or installer of the unit must ensure that it is used in such an environment.

DECLARATION – ELECTROMAGNETIC EMISSIONS		
Emissions test	Compliance	Electromagnetic environment – guidance
RF emissions CISPR 11	Group 1 Class B	The SitnStand for Wheelchairs uses RF energy only for its internal function. Therefore, its RF emissions are very low and are not likely to cause any interference to nearby electronic equipment.
Harmonic emissions IEC 61000-3-2	N/A	The SitnStand for Wheelchairs is suitable for use in all establishments, including domestic establishments and those directly connected to the public low voltage power supply network that supplies buildings used for domestic purposes..
Voltage fluctuations and licker IEC 61000-3-3:2013	Complies	



© 2022 **Life Assistant LTD**, all rights reserved.

No part of this manual may be reproduced in any form
without the written permission of **Life Assistant Ltd.**