

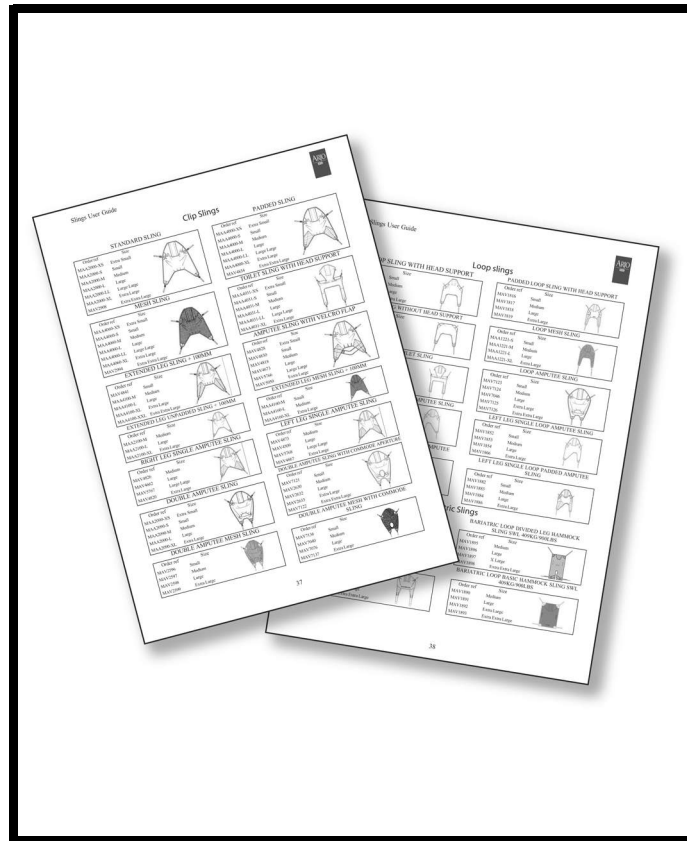

Arjo Sling™



Arjo Slings User Guide



MAX02360.INT

Issue 1

March, 2005

Contents

SECTION	Page No.
Introduction.....	3
Sling descriptions	4-8
Residents gallery	9-10
When using a sling always ensure	11-12
Maxislide.....	13
Care of your Arjo slings	14
Identification of quick reference symbols.	15
Components of a sling	16
Sling Size Guide Tape	17
Lifting From a chair	18
Lifting from a bed	19
Raising from the floor	20
At the toilet.....	21
2 Point Spreader Bar (Loop sling)	22-25
Lifting from a chair	22
Lifting from a bed and using the soft stretcher	23-24
Lifting from the floor	25
Patient specific Slings (Flites)	26
Bariatric slings	27
Standing and Raising slings- Loop and Lock and Clip fixings.....	28-32
Boss Slings	33-34
Walking jackets.....	35
Arjo Tailor Made slings.....	36
Sling Range and part numbers- Clip and Loop & Bariatric.....	37-39
Warning and safety instructions.....	40

Introduction

Using the correct sling for each patient is an essential element of safe patient handling. In some cases, medical and physical factors mean that a patient's comfort and safety can only be assured by the provision of a correctly fitted sling. Carers also benefit from fitting the correct sling on a patient as their work is made easier and there is less chance of back injury.

Arjo has long experience of making slings with people in mind.

A powered sling lifter offers the most secure transfer method for many patient-handling procedures. However, providing the optimum sling for the patient and the purpose is vital in order to ensure safety and comfort. A sling that is the wrong size or a bad fit for its patient creates discomfort and increases the risk of injury.

This guide has been produced to provide users of Arjo slings with the help and information they need to ensure safe and comfortable transfer of patients, whether it's from a bed, the floor, a chair or the toilet.

Clip Slings

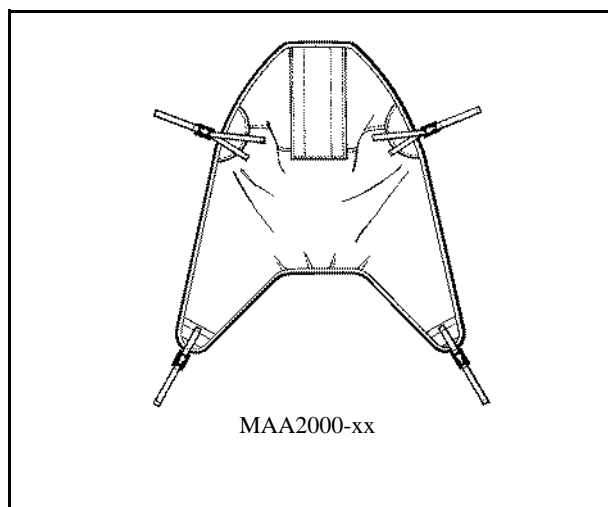

MAA2000-xx

Unpadding clip sling

The above has no padding in the leg area and therefore is easier to apply to residents with skeletal issues such as contractures and curvatures of the spine. These slings are commonly used on people who are in moulded wheelchairs.

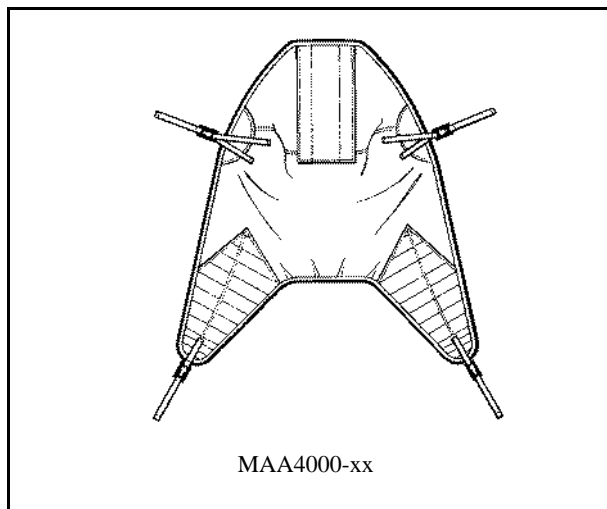

MAA4000-xx

Padded sling

Padding adds a level of comfort to the leg area of the slings. The Padding also helps to prevent the material roping and creasing under legs.

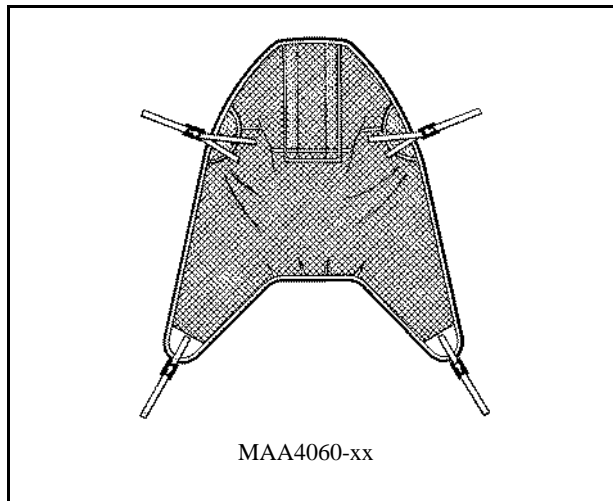

MAA4060-xx

Mesh clip sling

The above is most commonly used for showering or bathing. The mesh allows the water to pass through the material therefore retaining less water when the patient is being towel dried. This is a benefit when the patient is hoisted back into their wheelchair or onto a towel in bed. The porous material also allows the skin to breath and can be left underneath the patient.

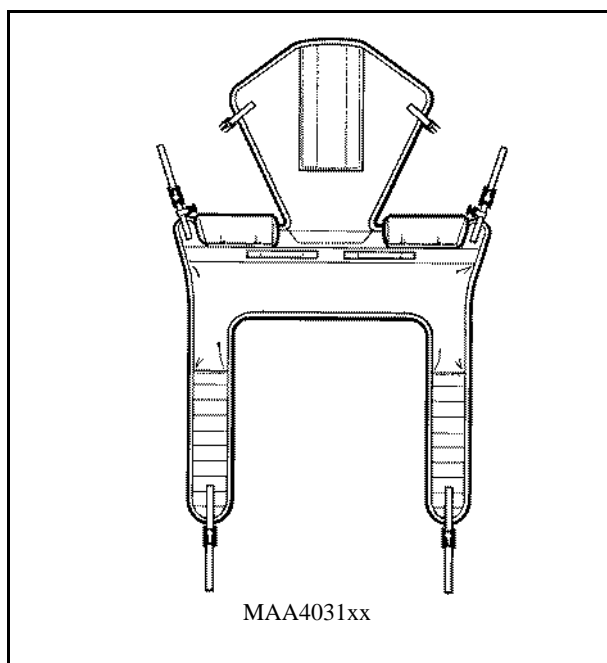

MAA4031xx

Toilet clip sling

Used for toileting, dressing and undressing patients. The padded arm supports provide the comfort and support. Leg supports are padded for comfort but again are narrower to allow clothing to be removed. Careful patient assessment is necessary before this sling is used.

Clip Slings

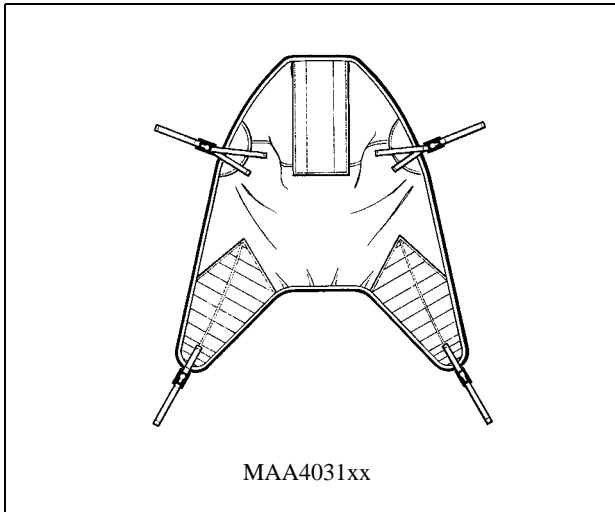

Extended leg padded clip sling

The leg pieces are extended by 100mm (4 inches) to allow easier attachment of the leg clips. Used for patients who have larger thighs and hips.

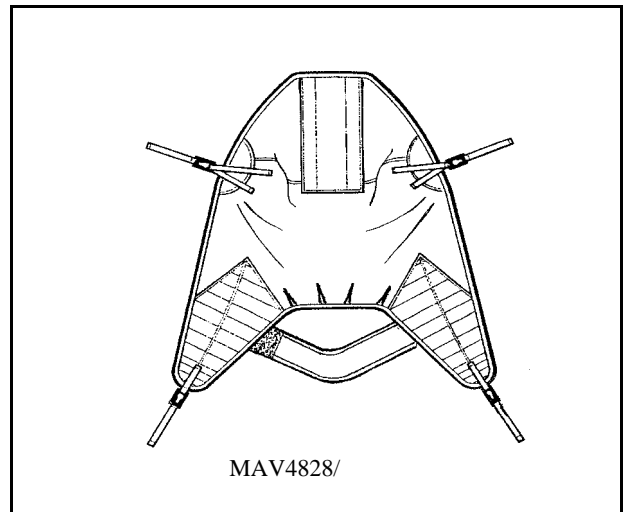

Amputee clip sling with Velcro flap

Used on double amputee above or below knee. The design allows easier application to the patient rather than having to log roll them in their chair or bed. The sling is applied as with a normal sling and the Velcro fastened to provide more support.

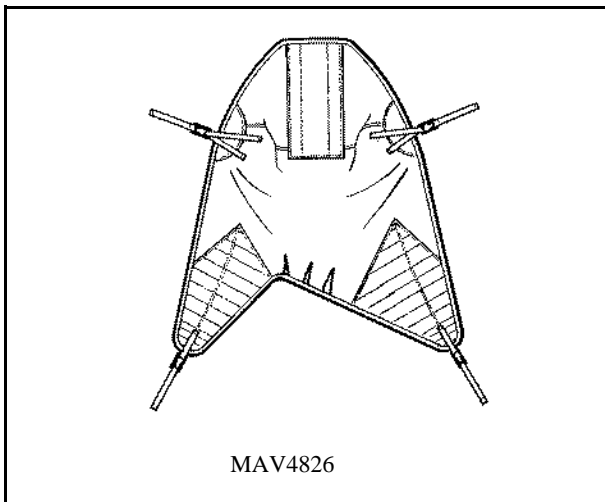

Right leg single amputee clip sling

Used for Left single leg amputee patients above, below or total hip. The larger leg piece provides more support to the stumps of the affected side.

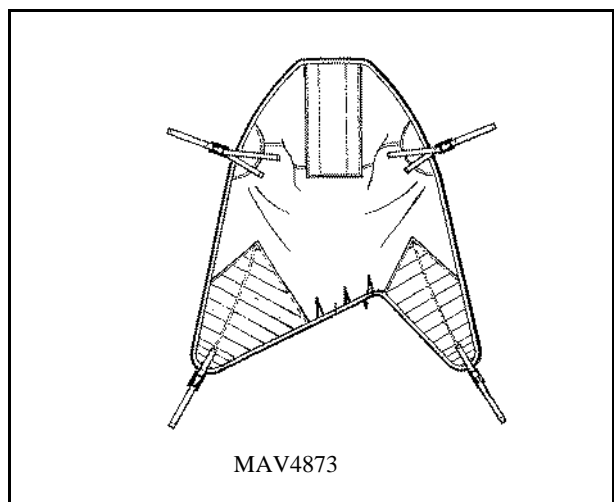

Left leg single amputee clip sling

Used for Right single leg amputee patients above, below or total hip. The larger leg piece provides more support to the stumps of the affected side.

Clip Slings

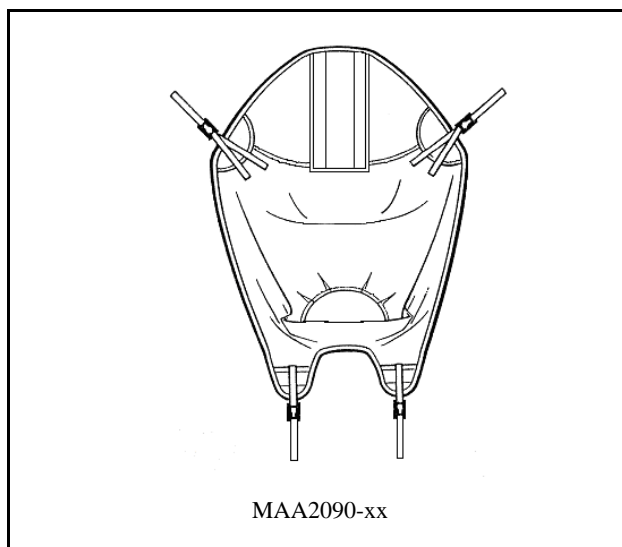

Amputee clip sling

Used for Bilateral leg amputee patients with above knee or total hip. The design requires the patient to be log rolled onto the sling while on the bed or rolled from side to side in a chair. The aperture does not allow toileting.

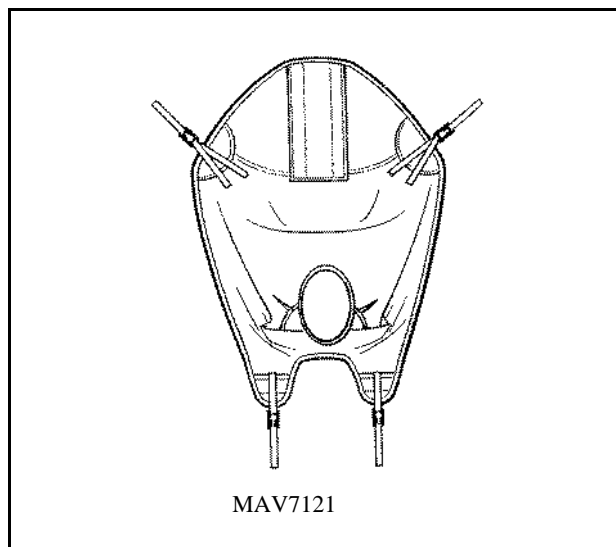

Amputee clip sling with commode aperture

Used for Bilateral leg amputee patients with above knee or total hip. The design requires the patient to be log rolled onto the sling while on the bed or rolled from side to side in a chair. The aperture allows toileting of a patient who's lower clothing has already been removed while on the bed.

Loop Slings

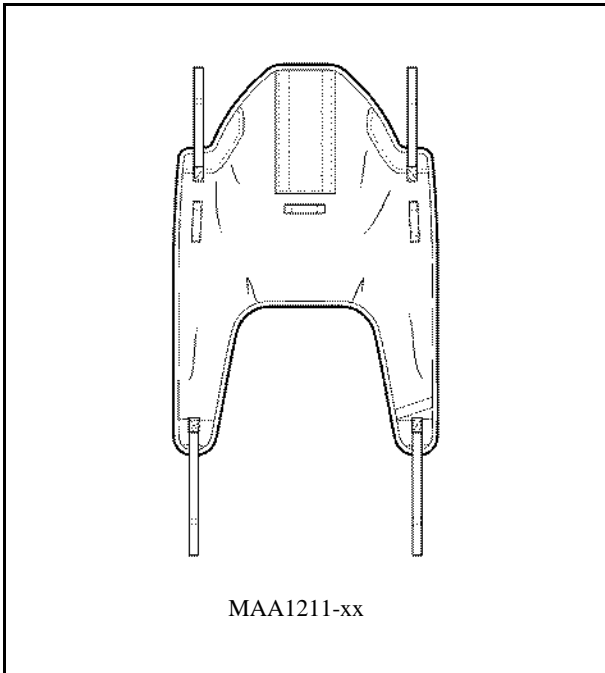

Unpadded loop sling

This sling has no padding in the leg area and is easier to apply to patients with skeletal issues such as contractures and curvatures of the spine. These slings are commonly used on people who are in moulded wheelchairs.

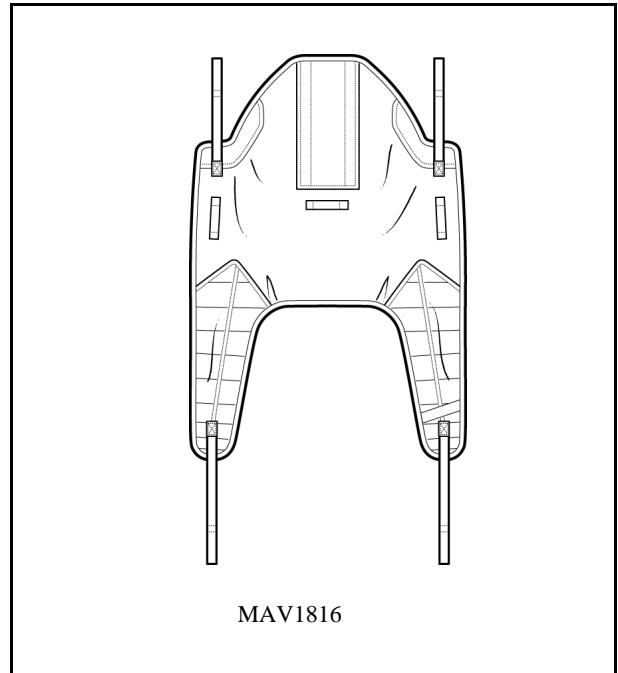

Padded loop sling

Padding adds a level of comfort to the leg area of the slings. The Padding also helps to prevent the material roping and creasing under legs.

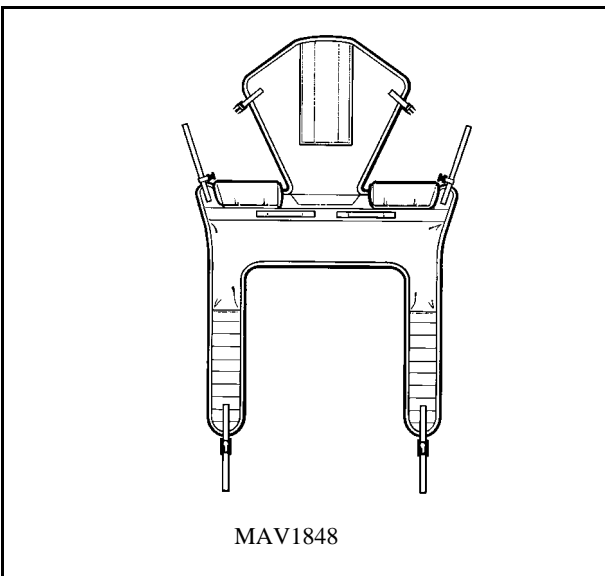

Loop toilet sling

Used for toileting dressing and undressing patients. The padded arm supports provide the comfort and support, which is lost when providing good access to the patient's perineum area. Leg supports are padded for extra comfort but again are narrower to allow clothing to be removed.

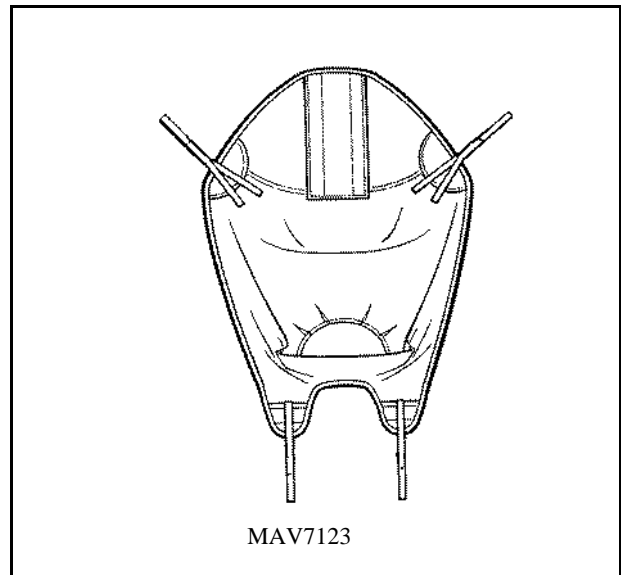

Loop amputee sling

Used for Bilateral leg amputee patients with above knee or total hip. The design requires the patient to be log rolled onto the sling while on the bed or rolled from side to side in a chair. The aperture does not allow toileting

Loop Slings

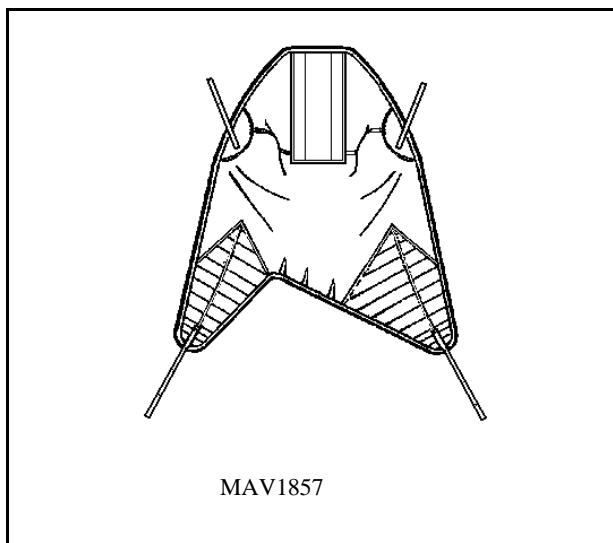

Right leg single amputee loop sling

Used for Left single leg amputee patients above, below or total hip. The larger leg piece provides more support to the buttocks and stump of the affected side.

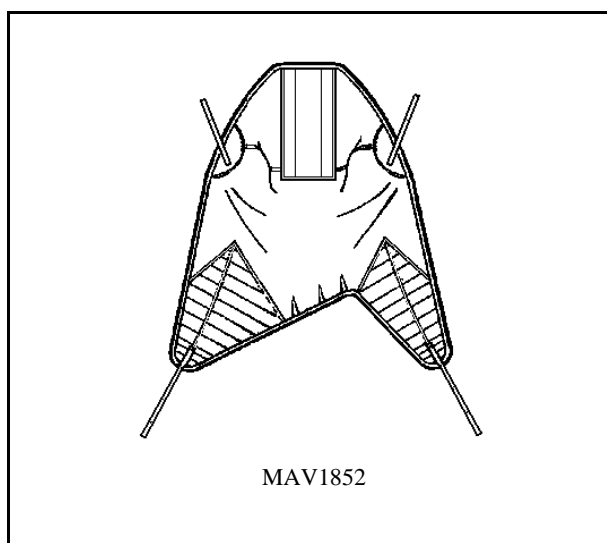

Left leg single amputee loop sling

Used for Right single leg amputee patients above, below or total hip. The larger leg piece provides more support to the buttocks and stump of the affected side.

Residents Gallery

Residents in elderly care and other facilities are very different, they have different diseases and problems and different backgrounds yet they all need to be offered a high quality of care.

Choices in care are made on the basis of assessments of each resident, choices tailored to their needs and desires as a "typical" resident does not exist.

In order to plan care for residents there needs to be a system of standardisation and classification. This is the reason Arjo developed the Residents Gallery, it is a classification of five typical residents based on their degree of functional mobility. But it is more than just a classification system; it offers colourful images of five residents who you would actually meet in real life health care settings. By envisaging them it makes it possible to discuss choices in care and rehabilitation in a realistic way.

We know them as Albert, Barbara, Carl, Doris and Emma and they represent the five different mobility levels (A-E).

ALBERT

CHARACTERISTICS

- *Ambulatory, but may use a cane for support*
 - *Independent, can clean and dress himself*
 - *Can tire quickly*
 - *Stimulation of abilities is very important*



The resident is able to perform daily activities by him- or herself without assistance from another person, It is possible that the resident needs special aids or appliances. As a rule

there is no risk of physically overloading the carer. Albert requires careful monitoring.

BARBARA

CHARACTERISTICS



- *Uses walking frame or similar*
- *Can support herself to some degree*
- *Dependant on carer who is present in demanding situations*
- *Not physically demanding for carer*
- *Stimulation of remaining abilities (e.g. ambulation) is very important*

The resident is partly capable of performing daily activities by him- or herself. However, the assistance that is required is in general not physically demanding for the carer/the nurse. The assistance may consist of verbal support, feedback or indications, but light physical assistance is also possible. This assistance can be given in combination with smaller aids (walking aids, support or grips and handles) or adaptations in the environment of the resident. Barbara's remaining capacity should be stimulated.

CARL

CHARACTERISTICS



- *Sits in wheelchair*
- *Is able to partially bear weight on at least one leg*
- *Has some trunk stability*
- *Dependant on carer in most situations*
- *Physically demanding for carer*
- *Stimulation of remaining abilities is very important*

The resident is not capable of performing daily activities by him- or herself, but is able to contribute to the action or perform part of the action by him- or herself. The assistance would, if given without special precautions, lead to the risk of physically overloading the carer/the nurse. The resulting load for the nurse would be in excess of safe limits for manual handling or static loads. In these cases it is necessary to use equipment that will reduce the exposure of the nurse to safe levels. The resulting load for the nurse would be in excess of safe limits for manual handling or static loads.

Residents Gallery

In these cases it is necessary to use equipment that will reduce the exposure of the nurse to safe levels. At the same time these residents are able to actively contribute to the movement and it is important for the resident to maintain or improve this capacity as much as possible. The assistance that is given in these instances is, for example, transfer using an active lifter. It is important to stimulate remaining capacity and slow down deterioration of mobility.

DORIS

CHARACTERISTICS



- *Sits in wheelchair*
- *No capacity to support herself at all*
- *Cannot stand unsupported and is not able to bear weight, not even partially*
- *Dependent on carer in most situations*
- *Physically demanding for carer*
- *Stimulation of remaining abilities is very important*

The resident is not capable of performing daily activities independently or to contribute to this actively in any substantial or reliable way. The assistance in this case will, without special precautions, result in a risk of physically overloading the nurse/carer. It is necessary to use equipment that eliminates this risk of overloading. The resident can, in this case, not contribute substantially to this movement. In spite of this, where- and whenever possible it remains important to activate these residents. The assistance provided in this case is for example the transfer with a passive lifter. An extra point of attention in this case is the prevention of the risks of immobility, (e.g. give good skin care). It is important to slow down deterioration of mobility.

EMMA

CHARACTERISTICS



- *Passive resident*
- *Might be almost completely bedridden*
- *Often stiff, contracted joints*
- *Totally dependent*
- *Physically demanding for carer*
- *Stimulation and activation is not a primary goal*

The resident is not capable of performing daily activities independently or to contribute to these activities actively. The assistance in this case will, without special precautions, result in a risk of physically overloading the nurse/carer. It is necessary to use equipment that eliminates this risk of overloading. In Emma's case it is not considered important any more to stimulate her to contribute to the movement and become active. Promoting or stimulating mobility and activating the resident is not a goal in the care plan anymore. Providing optimum care and/or prevention of the complications of immobility, e.g. good skin care, are given priority. Transfers will in this case be performed with for example a passive lifter. The aim is to avoid complications caused by long-term confinement to bed and make her as comfortable as possible.

When using a sling always ensure...

The sling is smoothly fitted from the base of the spine (coccyx) to the top of the head. (See fig 1 & 2) An indication of a badly fitted or wrongly sized sling may be that the head support is 3 or 4" (76-102mm) above (sling may be too large) or below the top of the head (sling may be too small).

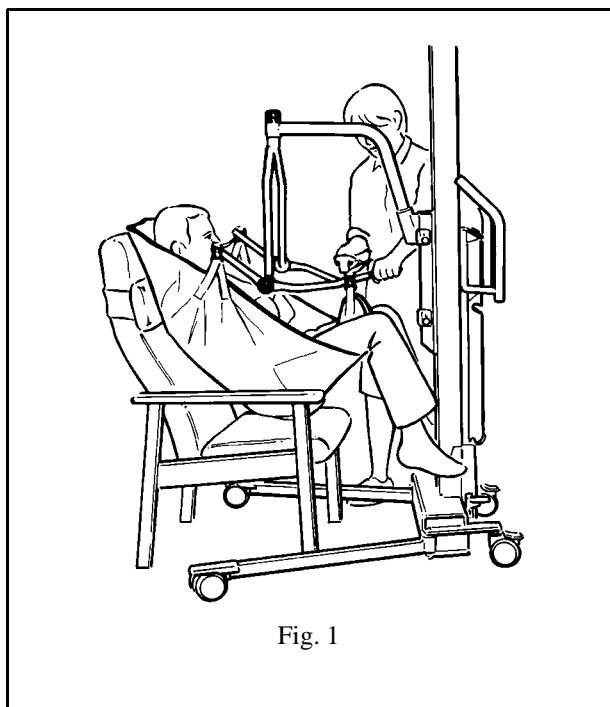

Fig. 1

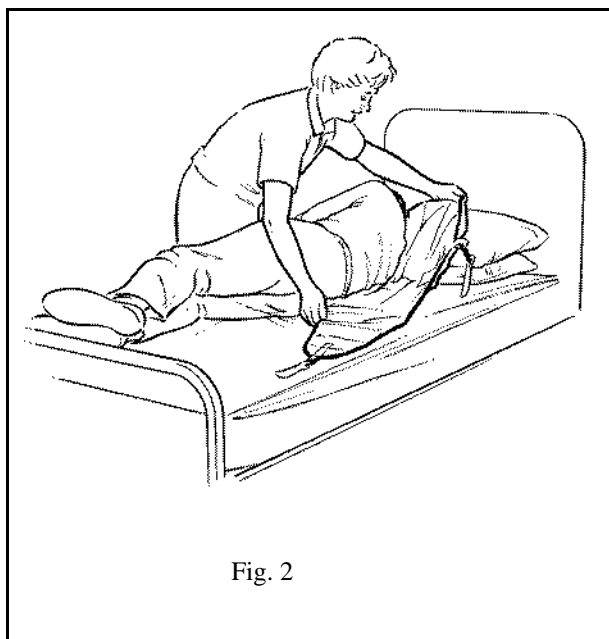

Fig. 2

Arjo have now produced a sling-size guide tape to act as a guide to fitting the correct size sling on a patient. (See fig 3)



Fig. 3

Instructions for using the sling-sizing guide are as follows.

- *Ensure that the tape is used the correct way round. (Teal (seaweed green) colour - XXS at the coccyx)*
- *Ideally the patient should be in a seated position*
- *Measure from the coccyx to the top of head. The colour level with the top of the head indicates the required size.*
- *If the size falls between two sizes always use the smallest size*
- *Patient width and body proportions, should also be considered and a professional judgement made*
- *This sizing tool is only intended as a guide and is an approximation. Other factors like the patients physical disabilities, weight distribution and general physique all need to be taken into consideration.*
- *The tape can be used to make dimensional records of patient for Tailor Made sling Requirements. (See fig 4)*

When using a sling always ensure...

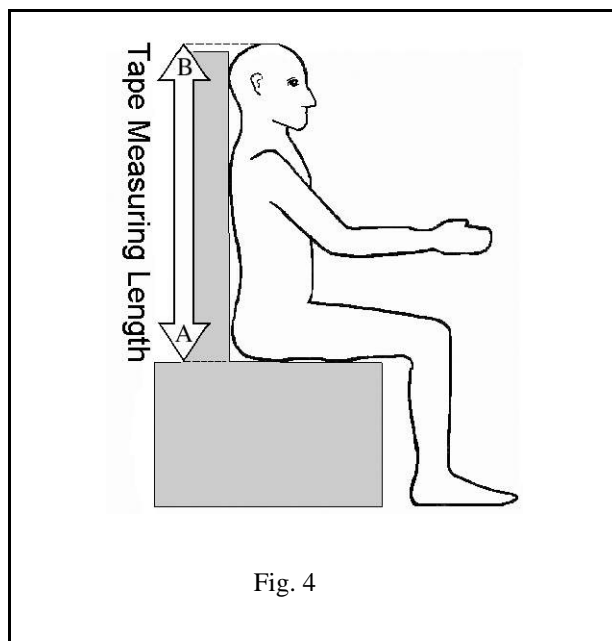

Fig. 4

During the lift, the patient will settle into the sling as their weight is taken up. Ensure the sling adequately supports the head and the patient's buttocks are not slipping through the sling aperture. (See fig 6) Should this happen stop the lift immediately and retry with a smaller sling size.

Centre line stitching has also been introduced down the back of Arjo slings to make it easier for carers to see exactly where the patient should be positioned in the sling. The centre line stitching should be positioned along the patient's spine to give the sling a perfectly centred fit.

Ensure the leg supports are placed smoothly under the patient's thighs so that the attachment clips/loops are between the patient's legs towards the middle of the thighs. (See fig 5) Indications of a badly fitted or wrongly sized sling may be the sling clips/loops only just appearing between the patient's thigh, (sling may be too small) or the leg supports of the sling digging into the back of the patient's knees with the sling clips/loops several inches above the front of the patient's thighs (sling may be too large).

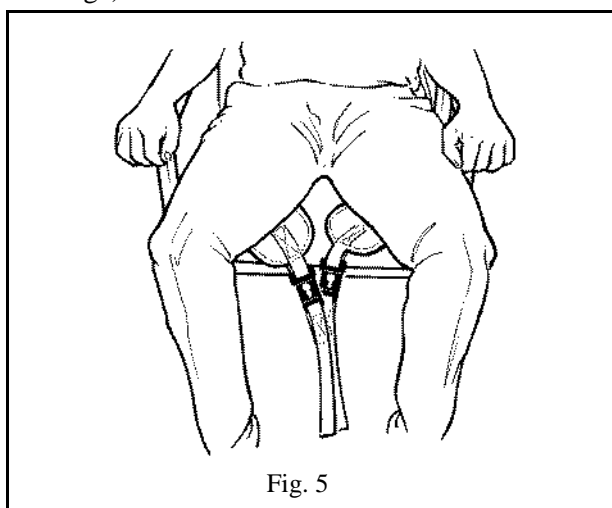

Fig. 5

Maxislide

52% of accidents and injuries that are suffered by nursing staff occur during manoeuvres in and around the bed.

Nurses have always recognised that the principle of sliding patients in bed reduces the effort, and have traditionally used sheets and even plastic bags to aid this movement.

The Maxislide is a unique, ergonomically designed device having ultra-low friction properties, which aid carers in moving or positioning patients whilst, at the same time, encouraging good posture without causing undue stress to either the patient or carer.

The Maxislide will also encourage patients to help themselves wherever possible.

The Maxislide CD-ROM is available which can be used as a user guide; its step-by-step instructions take the user through the most commonly used manoeuvres, showing at each stage how the Maxislide should be used.

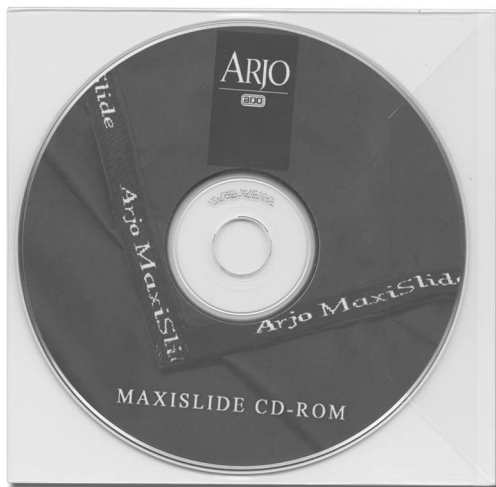

Maxislide CD

Care for your Slings

- *The sling should be inspected before use. It is essential that the slings, their stitching, their straps, the trim and attachment clips are carefully inspected. If the slings, trim or straps are frayed or cut or the clips show any signs of damage DO NOT USE. Consult the person responsible for Patient/Resident care. The sling should be withdrawn from use immediately and replaced.*
- *If the sling label is missing or cannot be read the sling should also be withdrawn from use.*
- *When laundering slings, they should not be classified as linen, but as a medical accessory to a patient transfer lifter and therefore classified as a medical device.*
- *Slings should be cleaned and disinfected only in strict accordance with the manufacturers instructions. (Refer to sling instruction sheet MAX. 81687- INT and MAX01510- INT, supplied with every sling and covered briefly below).*

- | |
|-------------------------------------------------------------------------------------------------------------------------------------------------------------------------------------|
| <ul style="list-style-type: none">• Note: <i>If the slings are contaminated or soiled then the following is a summary of the washing and drying procedure.</i> |
|-------------------------------------------------------------------------------------------------------------------------------------------------------------------------------------|

- *DO NOT IRON.*
- *Slings may be air-dried.*
- *Before washing remove plastic stiffness from the pockets in the sling and replace before use.*
- *Wash using normal detergents.*

Chemical Decontamination: Sodium hypochlorite (chlorine) 150-300 ppm (parts per million) or milligrams per litre, Low temperature tumble dry 40°C/104°F (test house conditions).

We recommend that the sling is washed before being used on the next patient, if suspected of being contaminated or soiled.

- | |
|---------------------------------------------------------------------------------------------------------------------------------------------------------------------------------------------------------|
| <ul style="list-style-type: none">• Note: <i>Note: Always follow washing guidelines indicated on the sling Washing and Using instruction label, prior to washing your sling. .</i> |
|---------------------------------------------------------------------------------------------------------------------------------------------------------------------------------------------------------|

Identification of quick reference symbols

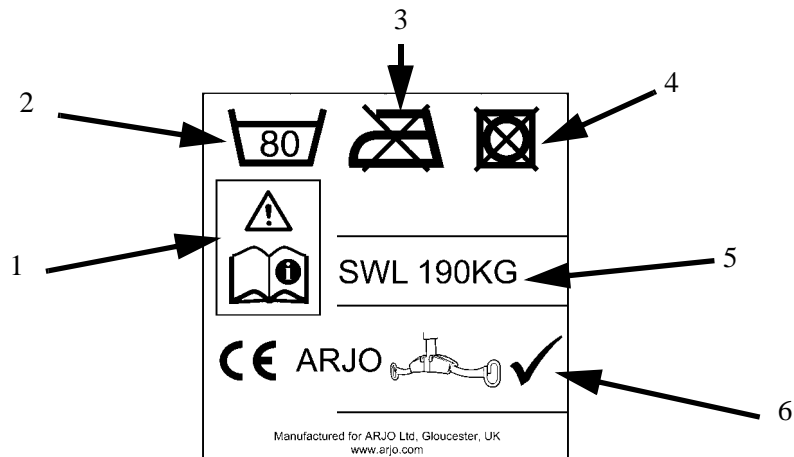

1. Stop and read Hoist Operating Instructions before using this sling
2. Maximum washing temperature °C
3. Do not iron
4. Do not tumble dry
5. Maximum weight to be lifted in kilograms - 190kg. Hoist lifting capacity may vary. Refer to hoist load rating label
6. Sling only to be used on Arjo Sling Lifters

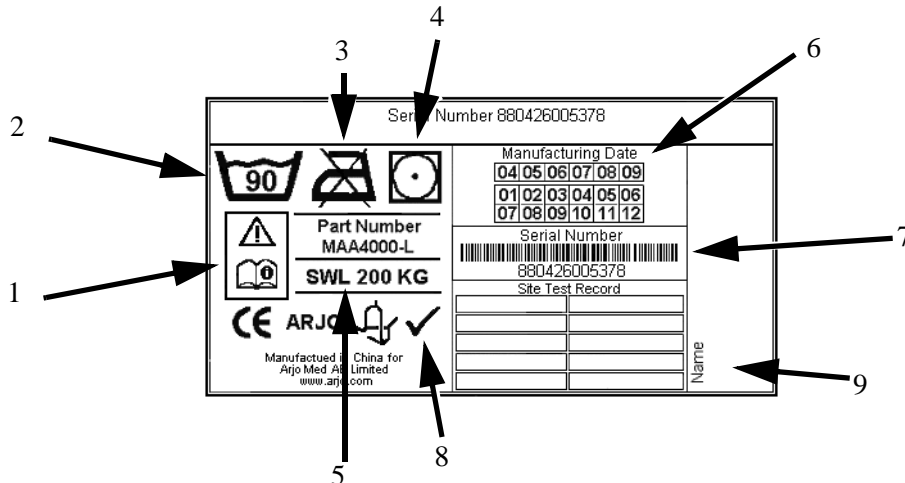

1. Stop and read operating instructions before using this sling
2. Maximum washing temperature (or 194°F)
3. Do not Iron
4. Low temperature tumble dry
5. Maximum weight to be lifted in Kilograms (or 440lbs)
6. Date of Manufacture
7. Serial number of sling
8. Sling only to be used on these Arjo sling lifters
9. Space for ward/facility/patient name

Components of a Sling

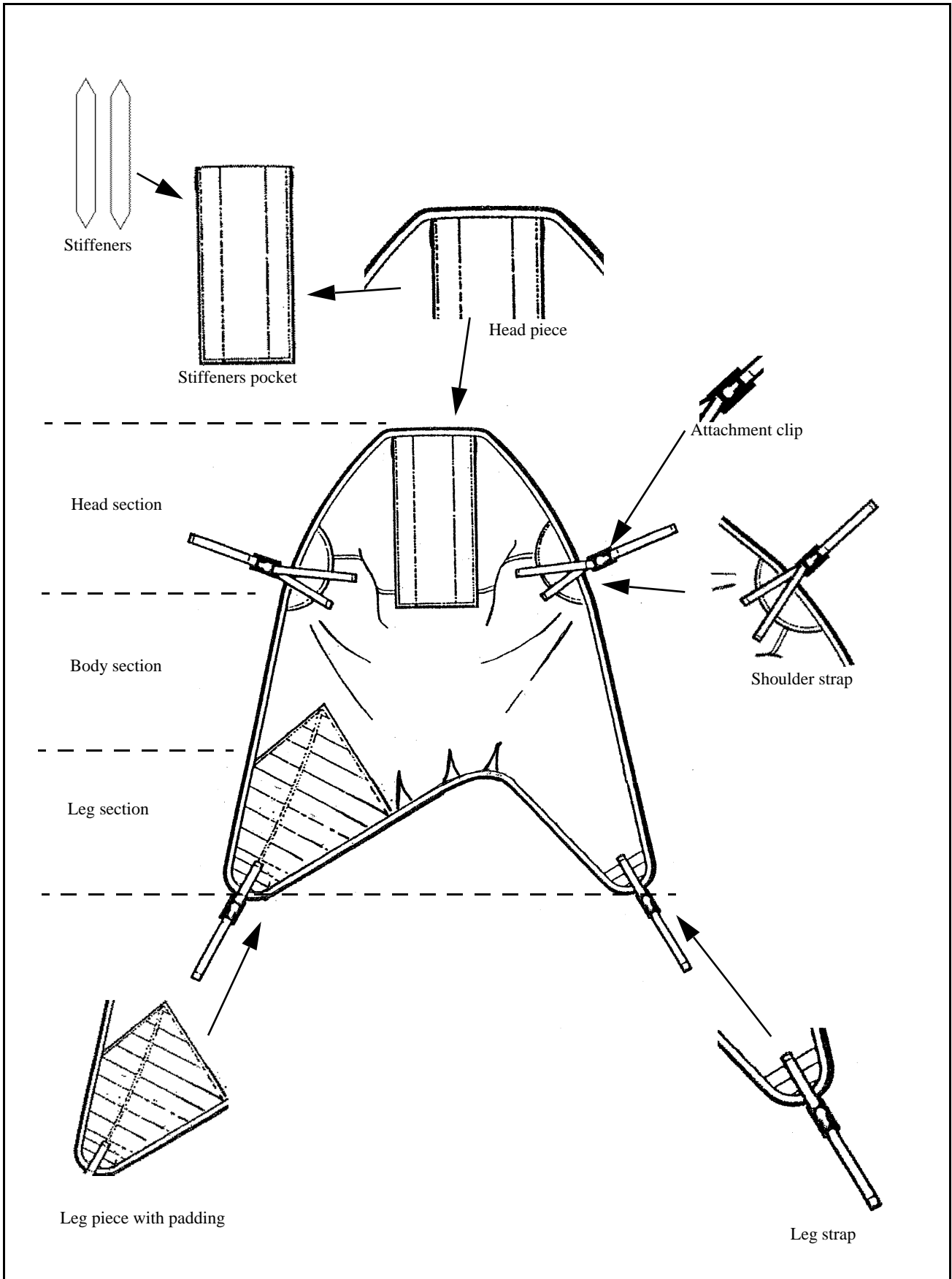

Sling Size Guide

Please refer to the sling-sizing guide tape, which can be used as a guide to which sling to use for or which patient. See page 11 for full instructions.

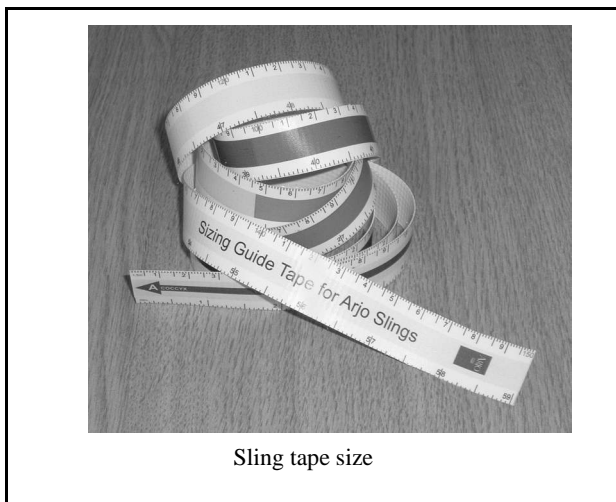

Sling tape size

The measuring tape has centimetres and Inches on it and is colour coded to represent to colour of the sling needed for the patient.

Arjos standard sling range is now available in 8 sizes. Extra sizes have been added to lessen the gap between each size and provide customers with greater choice and better fit. (fig a)

Arjo standing and raising aid slings are available in 4 sizes (fig b).

- Note:** IF THE PATIENTS WEIGHT FALLS INTO TWO SIZES OR THERE IS ANY DOUBT ON CHOOSING THE RIGHT SIZE SLINGS, ALWAYS GO FOR A SMALLER SIZE.

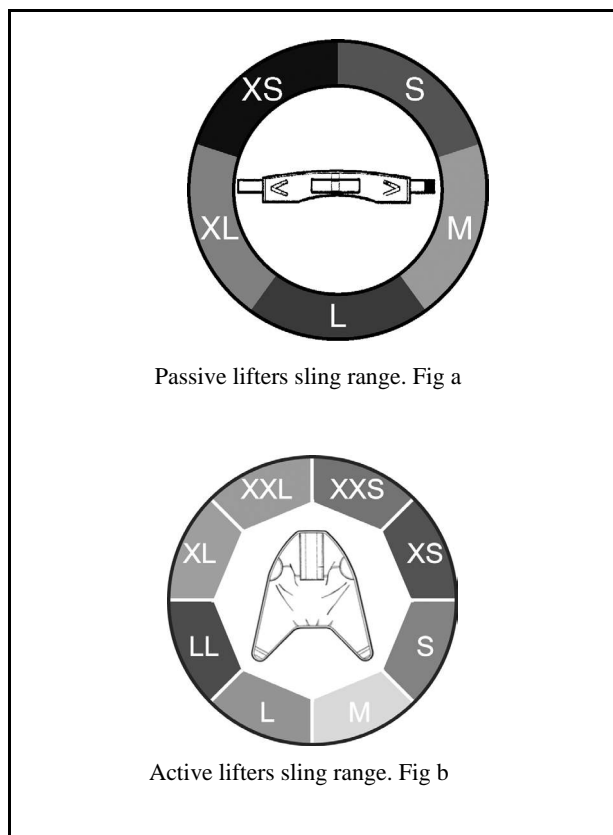

Passive lifters sling range. Fig a

Active lifters sling range. Fig b

All Arjo slings are tested to a maximum weight of 200kg or 440lbs.

This patient sling size guide is only an approximation, other factors which must be considered when selecting the appropriate sling are:

- Patient's distribution of body weight, i.e. hips, thighs, upper body.
- Patient's height, torso length.
- Patient's physical condition, i.e. amputee.

Sling size guide:

SIZE	COLOUR	WEIGHT RANGE	
Extra Extra small	Teal	0 - 25 Kg	0 - 55 lbs
Extra small	Brown	25 - 35 Kg	55 - 77 lbs
Small	Red	35 - 60 Kg	77 - 132 lbs
Medium	Yellow	55 - 75 Kg	121 - 165 lbs
Large	Green	70 - 120 Kg	154 - 264 lbs
Large Large	Purple	100 - 140 Kg	240 - 270 lbs
Extra Large	Blue	120 - 160 Kg	264 - 352 lbs
Extra Extra Large	Terracotta	160 - 190 Kg	352 - 418 lbs

Lifting from a chair

Using the Dynamic Positioning System ((DPS) Clip Sling)

Ensure the spreader bar is securely attached to the lifter before commencing with the lifting procedure. ('Lock and Load' combi system jib only).

Place the sling around the patient so that the base of his/her spine is covered, and the head support area is behind the head. Place each leg piece under the thigh so that it emerges on the inside of the thigh. (See fig. 1). You may wish to use the Maxislide to help in this situation. For reference, see Maxislide CD-Rom, Technique 24.

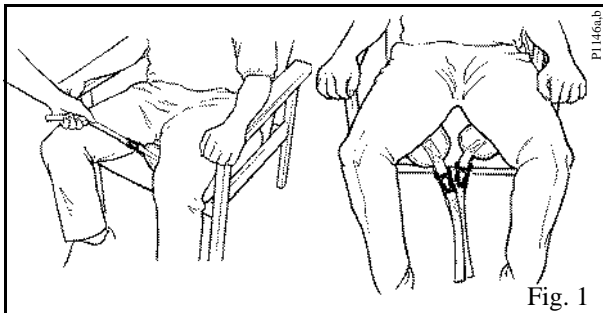

Fig. 1

Ensure the positioning handle on the spreader bar is facing away from the patient, and that the wide part of the spreader bar is at, or just below shoulder level. (See fig. 2).

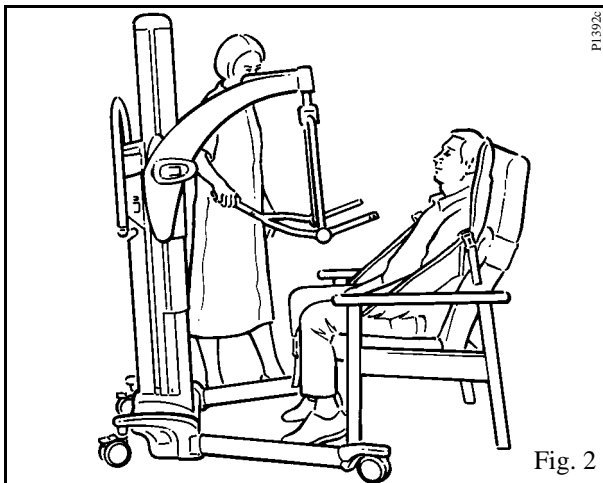

Fig. 2

Ensure that the Lifter is close enough to be able to attach the shoulder clips of the sling to the spreader bar. To accomplish this you may have to put the patient's feet on, or over the chassis.

Once the Lifter is in position, first attach the leg clips to the spreader bar; this will stop the patient slipping down. Then attach the shoulder strap attachment clips to the pegs on the spreader bar. (See fig. 3)

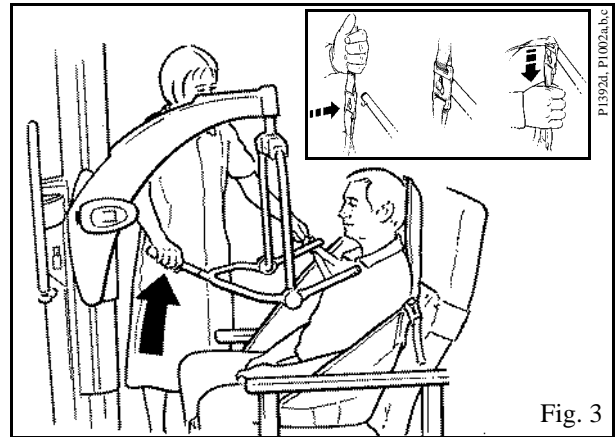

Fig. 3

If necessary, lower the spreader bar using the handset control, being careful not to lower it onto the patient, although if this should happen inadvertently, there is a built in cut-out device which will prevent any further downwards movement. Do not continue to press the handset-lowering button.

- **Note:** *If the handset button is released during lifting or lowering, powered motion will stop immediately.*

Raise the patient by operating the handset control, move the lifter away from the chair then carefully lift the positioning handle until the patient is reclined in the sling - the head support will now come into use. This is the most comfortable position for transportation, as it reduces pressure on the thighs. The angle of recline can be adjusted for increased comfort, if the patient is restless, using the positioning handle.

Before transportation, turn the patient to face the attendant at approximately normal chair height. This gives confidence and dignity and also improves the Lifter mobility.

Lifting from a bed

Position the patient onto the sling by rolling the patient towards you then folding the sling in half and placing it behind the patient's back (see fig. 1). Position the sling carefully so that when rolled back the patient will lie centrally on the sling (see fig. 2) and check that the head support area of the sling covers the patient's head. If the patient is unable to be rolled, either because of their size or the fact that they may be in pain, a Maxislide can be used to slide the patient onto the sling. Refer to the Maxislide CD-ROM for details of use.

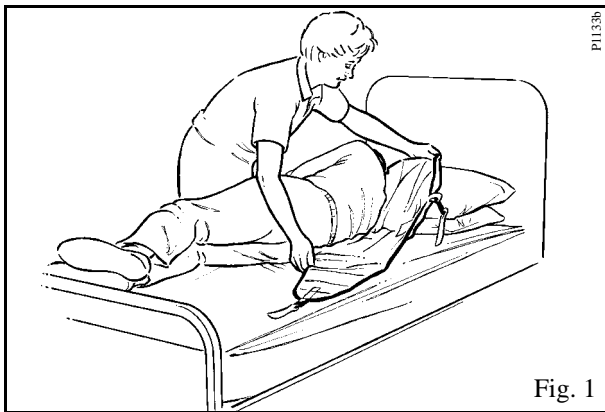

Fig. 1



Fig. 2

- Note:** When rolling the patient back onto the sling, roll the patient slightly in the opposite direction so that the folded part of the sling can be brought out.

Alternatively, the patient can be brought into a sitting posture then position the sling as detailed in the section "To Lift From A Chair".

Approach the bed with the open side of the spreader bar towards the patient's head. (See fig. 3).

Using the adjustable width chassis, it is possible to make adjustments to chassis leg widths to assist manoeuvrability around obstructions, for example, bed legs.

Position the Lifter so that the spreader bar is just above

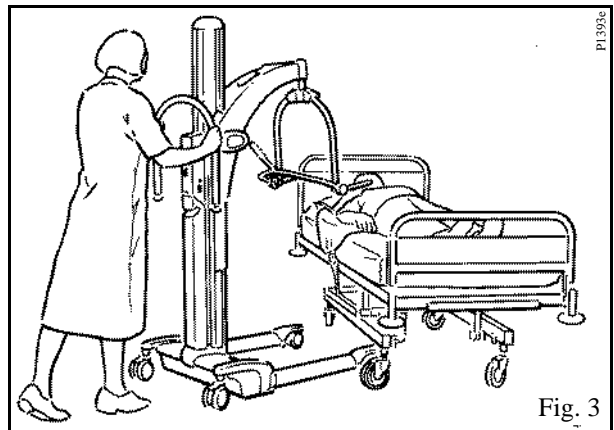

Fig. 3

Using the positioning handle, tilt the spreader bar until the shoulder attachment points can be connected to the sling shoulder strap attachment clips. (See fig. 4).

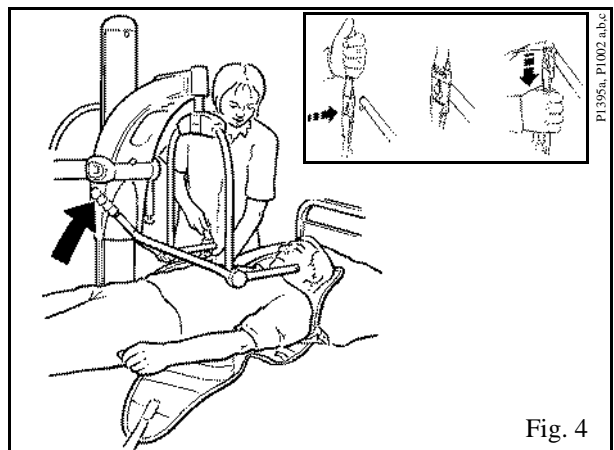

Fig. 4

Press down on the positioning handle until connection of the sling leg pieces is possible. (See fig. 5) The leg pieces must be brought under the thighs to connect up, this may involve supporting one leg at a time to connect up. You may need to lower the spreader bar a little more, using the handset control.

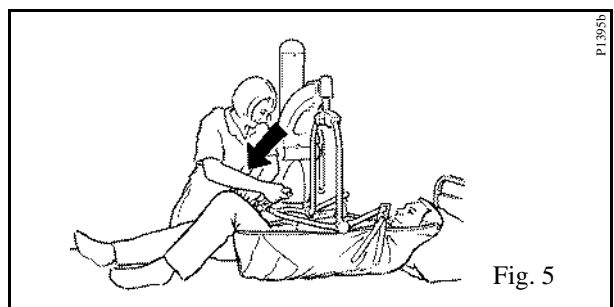

Fig. 5

Raising from the floor

Put the sling around the patient as before, either by using the rolling, sitting or Maxislide method.

Put the sling around the patient as before, by using the rolling or sitting up method or use the Maxislide if the patient cannot be rolled or sat up, see Maxislide CD-ROM Technique 27. Depending on circumstances, space and/or position of patient etc. approach the patient with the open part of the chassis. Open the chassis legs if necessary, and lift the patient's legs over the chassis as shown in fig 1.

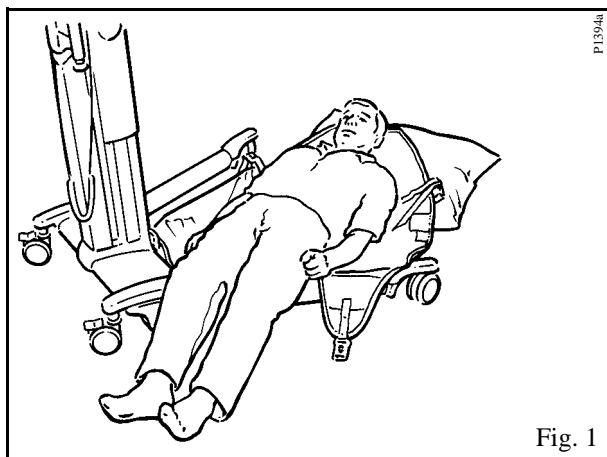

Fig. 1

The patient's head and shoulders could be raised on pillows for comfort, if required, but this is not essential when connecting up the sling to the spreader bar.

With the open part of the spreader bar pointing down towards the shoulders, attach the shoulder strap attachment clips, as shown in fig 2 and inset. The lifter's brakes should be applied once the lifter is in the correct position. This ensures the lifter does not move and injure the patient.

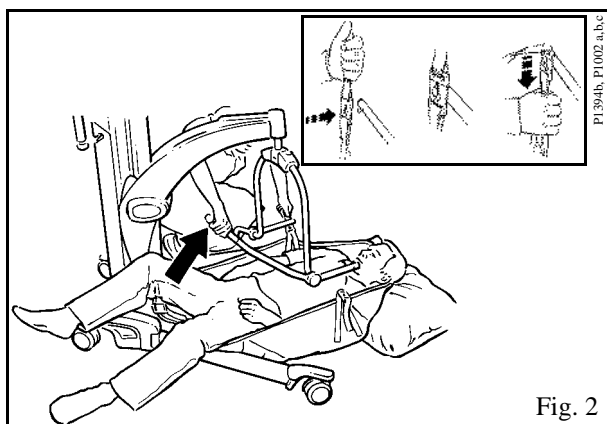

Fig. 2

Once connected, raise the hip and knee into maximum flexion, and push down on the positioning handle in order to connect the leg strap attachment clips as shown in fig 3. This will have

the effect of raising the patient's head and shoulders slightly.

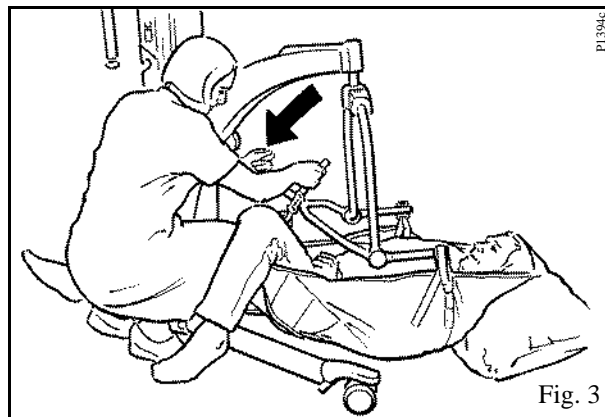

Fig. 3

When lifting from the floor, some attendants prefer to connect the leg pieces first. This in particular applies to the very large patient with large thighs. In this case, raise the hip and knee into maximum flexion, and attach the leg straps first, then tilt the spreader bar towards the shoulders to enable the shoulder straps to be connected.

When all the straps have been properly connected, raise the patient from the floor in a semi-recumbent position. Supporting the head can be comfortable and reassuring for the patient. Once raised from the floor, ensure the patient's legs are clear of the chassis before continuing to lift. (See fig. 4). The leg sections of the sling will tend to be fairly high up the thigh, so straighten them out for added comfort. The patient may be positioned in a chair, or placed onto a bed. If the patient is prone to extensor spasm, he/she may be lifted by the Arjo passive lifter, but special attention should be paid to supporting the legs during the early part of the lift.

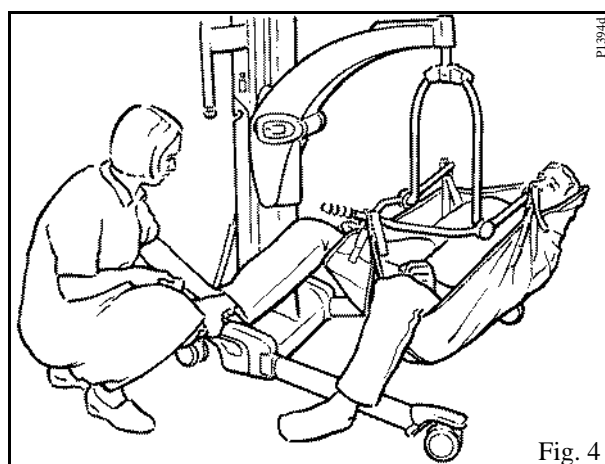
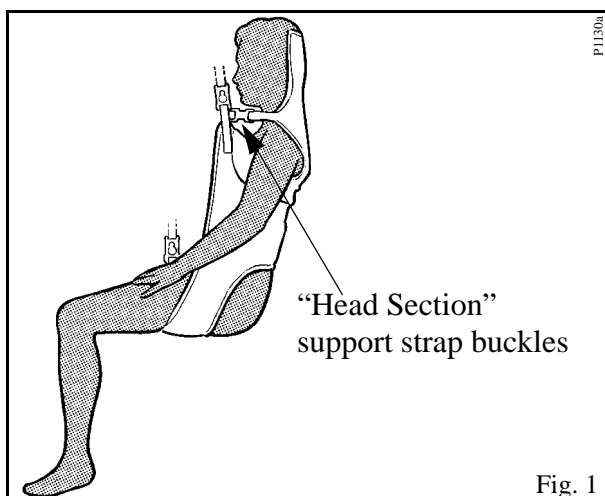

Fig. 4

At the toilet

- **Note:** *It is not advisable to use this sling with patients who are flaccid as they may slip through the commode hole.*

When toileting a patient, use the toilet sling with headrest. The toilet sling is fitted in a similar manner to the standard four point sling, except, the sling is not taken to the base of the patient's spine, but fitted with the top of the head support area of the sling level with the top of the patients head as a guide to positioning. (See fig 1)



The ARJO toilet sling has been specially designed to help support patients whilst toileting.

To provide the best possible access when toileting the sling has a wide commode opening and because of this it is essential that: -

- *The correct size sling is chosen, relative to the weight and height of patient and*
- *Both of the patient's arms are positioned outside the sling, over the padded areas but under the "head section" support straps' (See fig. 28) this will help prevent the patient from sliding through the sling.*

- **Note:** *It is advisable to release the "head section" support strap buckles prior to fitting the sling, once the sling is around the patient, reconnect the support strap buckles ensuring the patient's arms are positioned over the sling.*

When used in accordance with these instructions the toileting sling provides a very effective method of toileting dependent patients.

Once the patient has been lifted and transported to the toilet, position the lifter so that the patient is positioned above the toilet seat.

Apply the chassis brakes.

Unbutton and / or remove the patient's garments lower the patient to a comfortable sitting position

Lifting from a chair

Using a 2 point spreader bar (Loop Sling)

The slings to be used with the 2-point spreader bar are the ARJO loop slings. They are available in four sizes (small, medium, large and extra large) all colour coded. A range of more specialised slings are available please contact ARJO or their authorised distributors for details.

The loop sling is available with or without head support. A bathing mesh sling is also available in all the four sizes with or without head support.

Method 1 - Easing the patient forward, if necessary, slide the sling down the patient's back until seam "C" (see fig. a) reaches the base of the spine. Take attachment points "B" and loop the tails of the sling underneath the patient's thighs, ensuring the sling pieces are not twisted underneath the patient. Hook the loops onto the "opposite side" outer hooks on the spreader bar. (See fig. b).

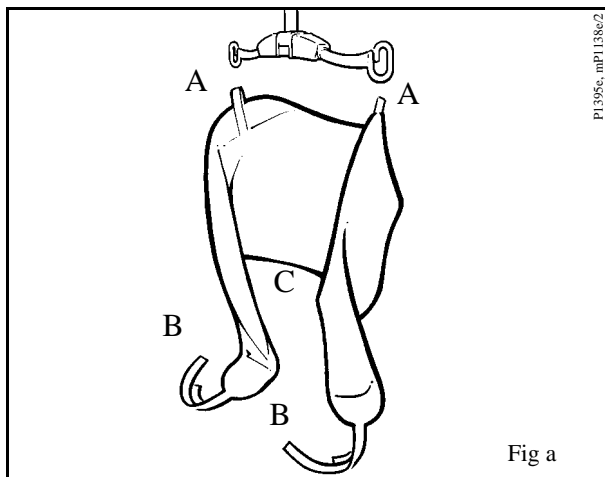

Method 2 - As method 1 above, but pass each tail portion of the sling under both thighs, and then out the other side before attaching points "B" to the outer hooks on the spreader bar (see fig. c).

METHOD 2

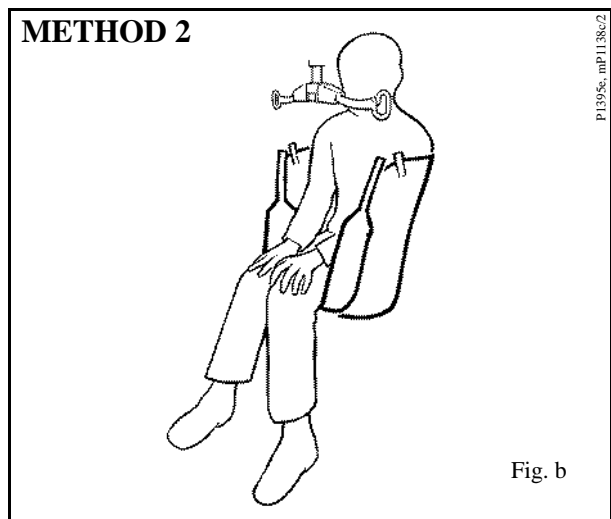

Method 3 - As method 1 above, but loop a tail portion of the sling under each thigh and attach to the same side hook as the shoulder attachment (left straps to left hook and right straps to right hook). This method holds the legs in abduction, and is useful for toileting (see fig. d).

- *Once the sling has been positioned and attached securely to the spreader bar then lifting can be carried out using the control handset. For general patient manoeuvring and transportation see also section "using 4 point spreader bar".*
- *Apart from the methods listed above, the 2 point spreader bar with loop slings is also extremely useful for lifting patients who have contracted legs, where the patient leg position prohibits the use of the 4 point spreader bar. Attach the sling in the normal manner as described in "lifting from the bed".*

METHOD 3

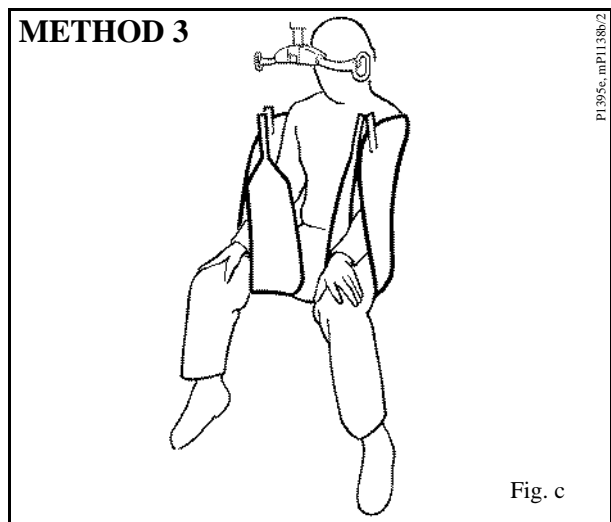

Lifting from a bed

Using a 2 point spreader bar (Loop Sling)

Place the sling under the patient as if it were a draw sheet (log-roll). Flex the patient's legs, and bring the sling leg pieces under the thighs, attach the sling to the spreader bar using any of the methods 1-3 in 'Lifting from a chair'. Alternatively the Maxislide method can be used in this instance for sliding the sling underneath the patient, if he/she cannot be log rolled.

Using the soft stretcher



Warning: Before the stretcher can be used with the Hoist, ensure the Arjo stretcher support frame has been correctly fitted to the carrier. Once fitted correctly, the stretcher frame should be able to rotate approximately 90° about its axis. Do not fit the stretcher frame in line with the jib.

The soft stretcher is intended for use with the stretcher frame and is available in two sizes, large and extra large. It is also supplied in either plain polyester or polyester mesh for washing use; both types are available with or without commode hole. To lift a patient using the stretcher frame and soft stretcher proceed as follows:

Identify the head of the soft stretcher; a label sewn to the head end will confirm this.

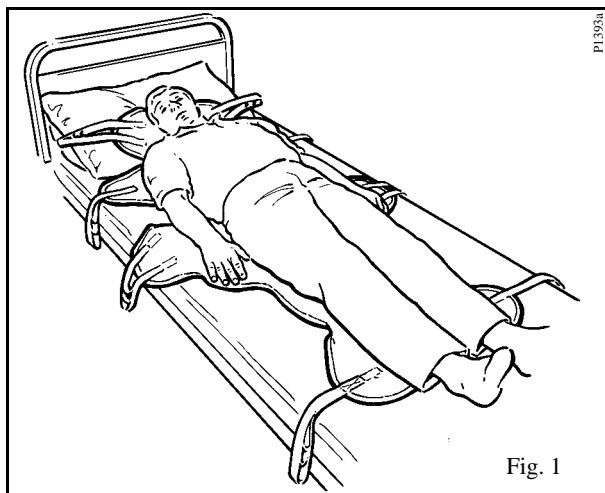

Fig. 1

Position the soft stretcher sling as shown in figure 1 by rolling the patient as if inserting a draw sheet. Ensure the top section of the sling (indicated by the label attached to the sling) is under the patient's head, with the top edge of the sling level with the top of the head. With the stretcher frame as high up as possible (but not to come into contact with the patient, should it swing accidentally), move the

Lifter until the frame is directly over the patient, the frame is symmetrical and can be used either way round. (See fig. 2). Lower the stretcher frame carefully over, and just clear of the patient, aligning the center of the frame approximately over the patient's navel. Connect all the sling loops securely

(See fig. 3). Note: The attachment straps have several connection loops, choose whichever loop is considered the best to enable the patient to lie in the most comfort

able position. (See fig. 4).

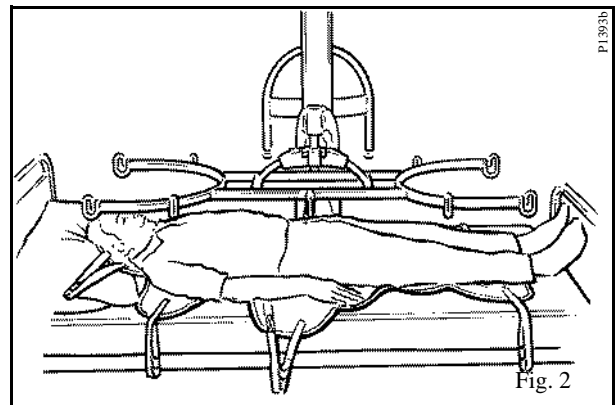

Fig. 2

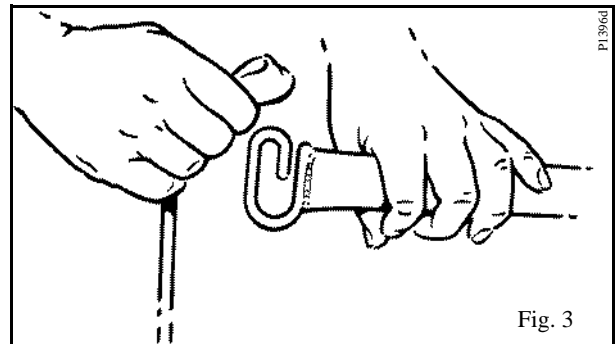

Fig. 3



Warning: It is essential to keep the patient at approximately normal bed height to ensure stability of the unit and without losing patient/attendant contact.

When lowering the jib ensure that the patient's or attendant's legs and feet are well clear of the moving mast.



Warning: Only use soft stretchers that have every attachment strap coloured blue.

Lifting from a bed

- **Note:** *The "head end" straps have a black tab stitched to them to enable correct usage with other Arjo stretcher frames. Do not use any other type of soft stretcher sling with the Arjo Hoist*

The stretcher frame is classified by Arjo as a wet environment unit, and has a blue and white circular label to qualify this, attached, (See "Labels" section). This label signifies that the unit may be immersed in bath water or used for showering.

Lifting from the floor

- *Some attendants prefer to use a larger sling for this operation as a larger sling leaves more room between the patient and the spreader bar, making the patient feel more comfortable*
- *Apply the brakes on the lifter so the patient is safe from the moving wheels. Raise and support the patient into a sitting, or half-sitting position. Feed the sling down the patient's back; bring the leg pieces of the sling into position. Raise the patient's legs over the chassis, and bring the lifter into position as shown in picture opposite. With the jib as low as possible, attach the shoulder loops. Bend up the patient's knees to connect up the leg pieces.*
- *When lifting or lowering a patient who is supported by a sling it is not necessary to use the brakes, this allows the Lifter to move to the correct position relative to the centre of gravity of the patient.*
- *When the patient has been returned to the bed he/she may be reclined before the sling is detached.*

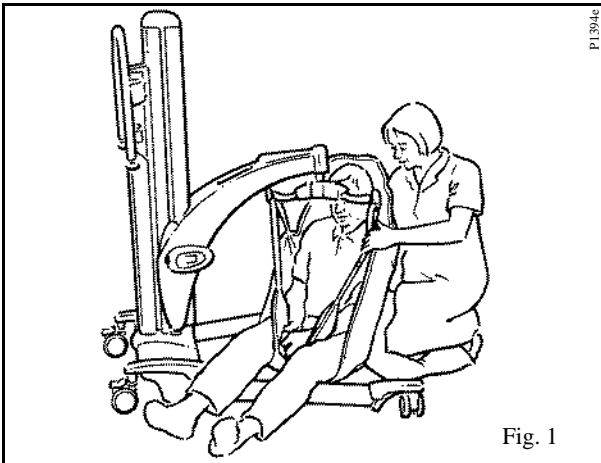

Patient Specific Slings (Flites)

Arjo Flites are Patient specific disposable slings. They can be used in exactly the same way as standard Arjo slings but they cannot be washed.

As Arjo Flites are patient specific they reduce the risk of cross infection and can easily be disposed of if soiled, damaged or suspected of being contaminated.

- Before using your Arjo Flites, familiarise yourself with the method of sling operation detailed in this document and your lifter operating and product care instructions.



- Arjo Flites must be used in accordance with this information sheet and in conjunction with the operating and product care instructions issued for your lifter. Flites are designed to be disposable and not laundered so disregard the instructions for laundering slings.
- Arjo Flites have been designed to support hospital or care facility patients while using a patient transfer lifter, under the supervision of trained nursing staff. All other uses must be avoided.
- All Arjo Flites sizes will support 190kg (420lbs) and are coded for size by the colour of the edge binding tapes, but before using always refer to the maximum weight limit of the lifter or attachment being used.
- Each Arjo Flite sling is intended to be specific to the patient, ensuring that it is always the correct size, comfortable and having respect for personal hygiene.
- Arjo Flites can be supplied with two styles of attachment, the Arjo four point system (four plastic clips) or with loop attachment straps.
- When the correct size has been determined for a particular patient, using a permanent marker, write the patient's name or reference and the date of issue in the space provided on the label sewn to the side of the sling. The Flite can be retained to be re-used with the patient as required until either the Flite has been soiled, damaged or is suspected of being contaminated or if the patient no longer requires it.
- If using Flites with attachment clips, ensure the "pull straps" at the end of each attachment clip are only used to attach/detach the clips from the spreader bar, they must not be used for any other purpose. Do not use the "pull straps" as

an aid to position the patient whilst in the sling. Improper use of the "pull straps" could result in damage to the sling or injury to the operator or patient. Always ensure that the straps connecting the sling to the attachment clips are not twisted when the attachment clips are connected to the spreader bar.

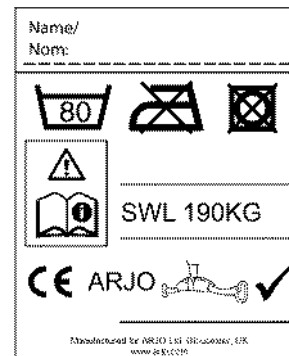

- For patient comfort and label visibility, Arjo Flites should be used with the DO NOT WASH label (see Fig. 2) and the attachment straps to the outer side, and not against the patient.
- Arjo Flites with head support have two pockets situated at the head section, which should contain plastic re-inforcement pieces during use. Always ensure these re-inforcement pieces have been inserted into the pockets before using the Flite. Before disposing of the Flite remove the re-inforcement pieces and retain them for re-use. Decontaminate the re-inforcement pieces before re-using with Isopropyl alcohol wipes (see "Care" section in main lifter operating and product care instructions)
- Flites are designed to be used for a limited period only and by their nature of design must be treated as a disposable product.
- If the Arjo Flite is inadvertently washed or immersed in water, this label disintegrates to display the DO NOT USE symbol (see Fig. 3). The Flite should then not be used under any circumstances.
- It is essential that the Arjo Flites, their straps and attachment clips are carefully inspected before each and every use. If the Flite fabric or straps are frayed, or the clips damaged or the DO NOT USE symbol is visible, the Flite should be discarded immediately and disposed of in accordance with hospital or care facility policy.



Bariatric slings

Bariatric comes from the Greek word 'Baros' meaning heavy. It is a term given to people who are generally over the 25 stone or 160kgs. Arjo have developed a range of slings especially for Bariatric patients which all have a safe working load of 409kgs or 900lbs. The range comprises of four

slings and are available in four sizes they are a range separate to the standard sling range available from Arjo. There are two that are standard shaped Arjo slings and two hammock style slings.

BARIATRIC LOOP PADDED SLING SWL 409KG/900LBS

Order ref	Size	
MAV1836	Medium	
MAV1837	Large	
MAV1839	X Large	
MAV1840	Extra Extra Large	

BARIATRIC LOOP BASIC PADDED SLING SWL 409KG/900LBS

Order ref	Size	
MAV1990	Medium	
MAV1991	Large	
MAV1992	Extra Large	
MAV1993	Extra Extra Large	

BARIATRIC LOOP DIVIDED LEG HAMMOCK SLING SWL 409KG/900LBS

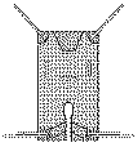
Order ref	Size	
MAV1895	Medium	
MAV1896	Large	
MAV1897	X Large	
MAV1898	Extra Extra Large	

BARIATRIC LOOP BASIC HAMMOCK SLING SWL 409KG/900LBS

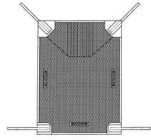
Order ref	Size	
MAV1890	Medium	
MAV1891	Large	
MAV1892	Extra Large	
MAV1893	Extra Extra Large	

Standing and Raising slings- with clip fixing

Position the sling around the patient's back so that it lies 50mm (2") or so, horizontally above the patients' waistline, with the patients' arms outside the sling. Ensure the support strap is separated, brought loosely around the body, and is not twisted or trapped behind the patients' back.

Fasten the support strap securely; the strap should be tight, but comfortable for the patient. (See fig. 1). The support strap will assist in supporting the patient in the sling during the lifting procedure.

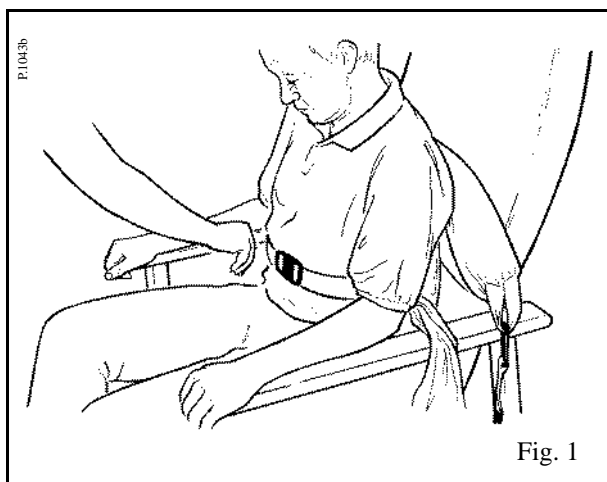

Bring the Lifter carefully up to the patient, placing the patient's feet on the footrest, and continue forward until the kneepad is just in contact with the patient's knees and upper shin. Put on the brakes. (See fig.2).

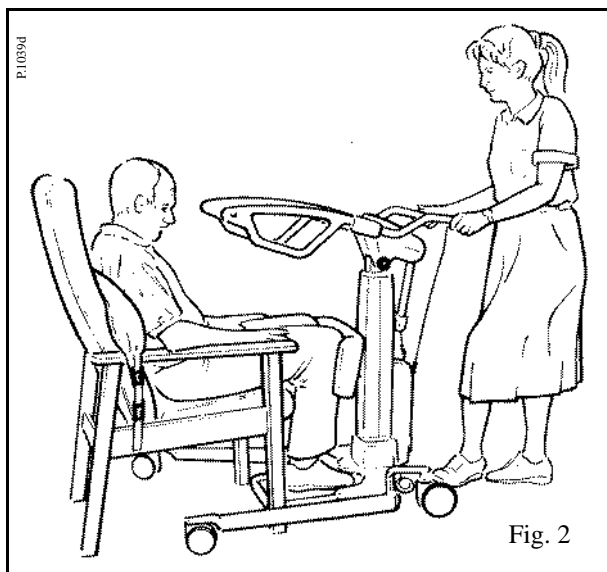

Lower the support arms carefully, using the handset control, until the sling attachment lugs on the support arms are close enough to connect up to one

of the sling attachment clips. (See fig. 3).

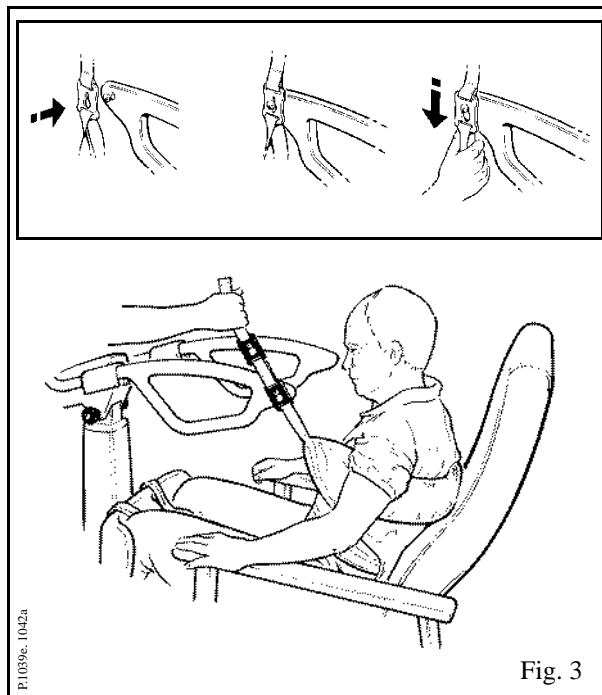

Next, select an appropriate clip on the opposite end of the sling, and connect up.

- **Note:** The patient should be supported but not pulled forward too much.

Ensure the sling clips are pulled well down onto the attachment lugs and secure, before attempting to lift the patient.

If possible, the patient should now hold onto the grab handles with one or both hands. (See fig. 4).

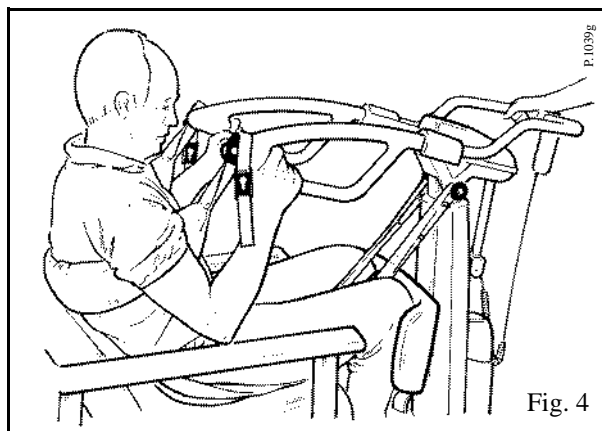

Standing and Raising slings- with clip fixing



Warning: Always check that all the sling attachment clips are in position before and during the commencement of the lifting cycle and in tension, as the patient's weight is gradually taken up

If the patient can stand sufficiently well to lock his / her knees in the normal way, their knees will come away from the reaction pad, and he/she can just lean back into the sling. (See fig. 6)

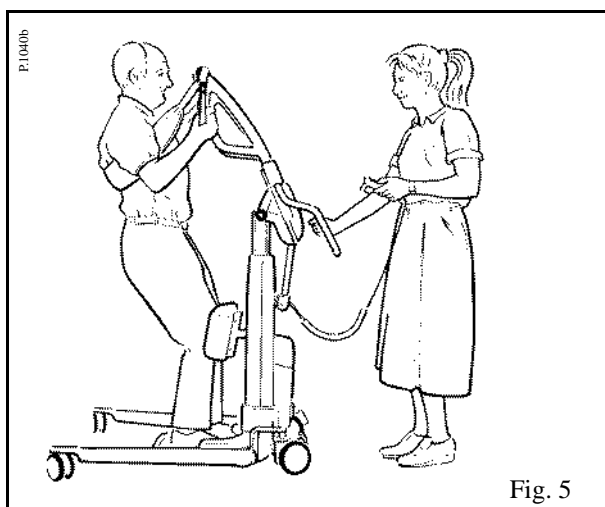

Fig. 5

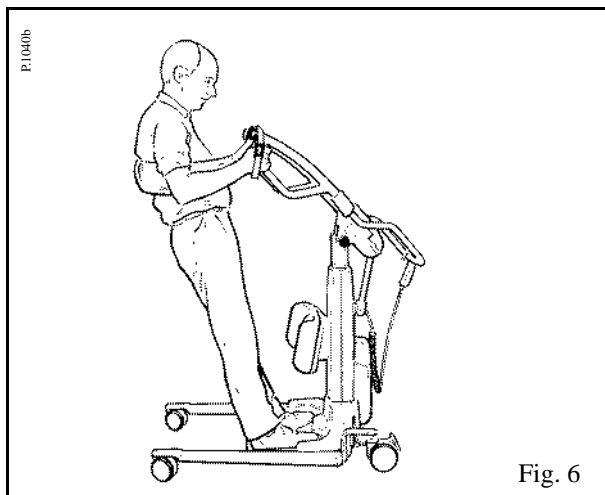

Fig. 6

If the patient is "slumped", he / she can still lean back into the sling, and be kept in the raised position by the knees being in contact with the kneepad.

Patients who have suffered a "stroke" who can only hold with one hand, or patients who cannot hold on at all, may still be lifted in this way, but it will be necessary for the attendant, (or a second attendant), to hold the patient's arm / arms down in front of the body during the lift.

- **Note:** Patients wearing nylon nightdresses / dressing gowns are prone to be "slippery" - the sling may ride up the back causing slight pressure under the arms. It may be necessary to hold the sling in position when lifting or lowering.

Release the brakes, and transfer the patient to new position, i.e. toilet, wheelchair, chair, bed, etc.

- **Note:** Transportation is possible with the chassis legs open or closed, but it will be easier through doorways etc. with the chassis legs closed.

While the patient is raised, make any necessary adjustments to clothing, incontinence pads etc. before lowering again. Lower the patient carefully using the handset control.

Apply the chassis brakes if leaving the patient at the toilet, or if leaving the patient unattended.

When the patient is in the new position and seated, and you wish to remove the sling, unclip the shoulder support attachment clips, then release the support strap.

Do not attempt to release the support strap while the sling supports the patient.

Remove the sling from the patient.

- **Note:** If the patient lacks sitting balance and has been returned to the bed on the Lifter, a second attendant may be needed to support the patient while the sling is being removed. (See fig. 7)

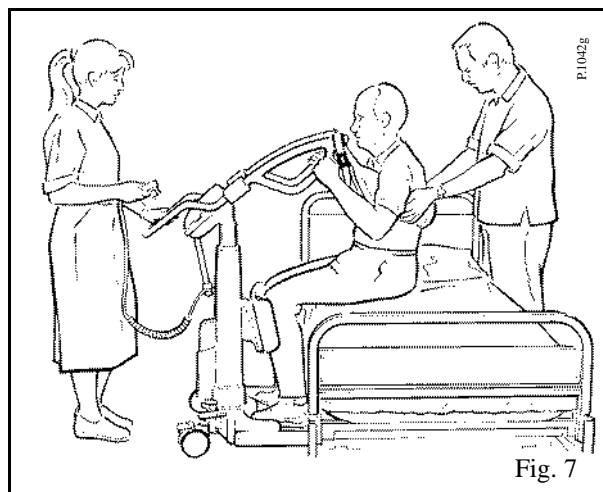

Fig. 7

Standing and Raising Slings- with loop and lock

Allow the patient to hold the handgrips, with their arms resting on the Arc-Rest. This will not apply if fitting the sling around the patient before the lifter is brought into close proximity.

Encourage the patient to lean slightly forwards to enable the sling to be placed around the lower back of the patient (see Fig. 1). Position the sling around the patient's back so that the bottom of the sling lies horizontally approximately two inches above the patient's waistline, with the patient's arms outside the sling. Ensure the support strap is separated, brought loosely around the body, and is not twisted or trapped behind the patient's back.

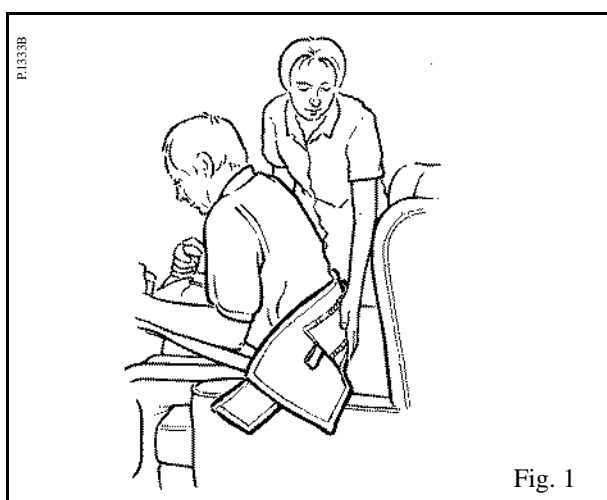

Fig. 1

3. Fasten the support strap securely by overlapping and pressing the "Velcro" together. The strap should be tight, but comfortable for the patient. (See Fig. 2).

- **Note:** The support strap will assist in supporting the patient in the sling during the lifting procedure. The strap also retains the sling in the correct position around the patient.

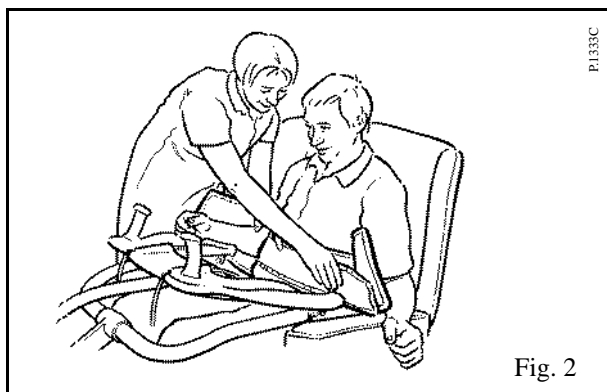
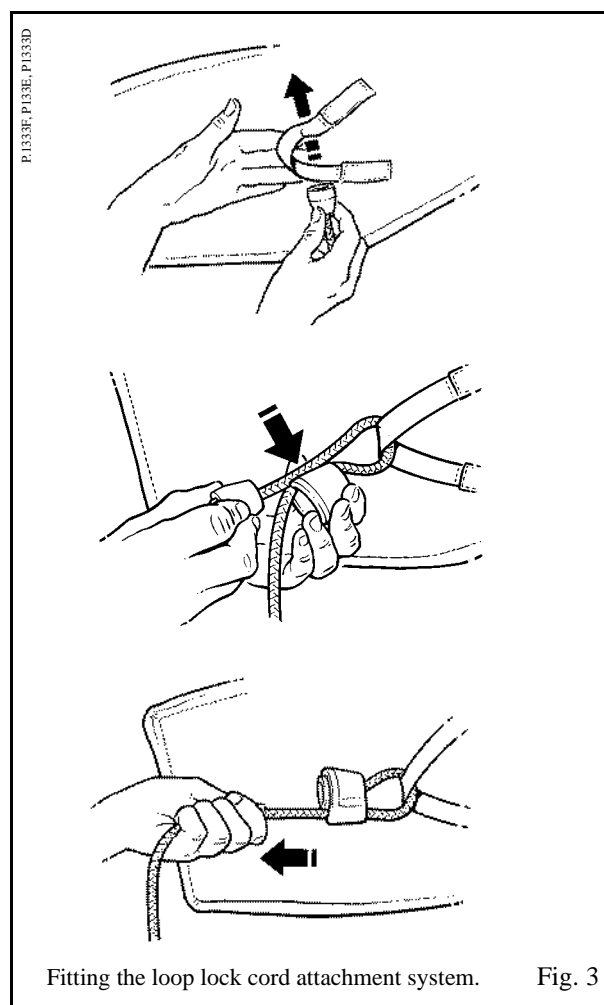

Fig. 2

If the Lifter is not already in close proximity to the patient bring it to the patient as described previously.

Take each adjustment cord in turn and attach to the sling. (See Fig. 3).

When both cords are attached correctly make adjustments on both cords equally so that any slack is taken up in each cord and the back section of the sling supports the patient comfortably and securely, lock the adjustment cords down into the cord retaining cleats. (See Fig. 4).



Fitting the loop lock cord attachment system. Fig. 3



Warning: Ensure the cone is pulled tightly into the cup section. (See Fig. 3)



Warning: Ensure the cord end knobs are away from the pro-active pad TM when the patient's legs are near or in contact with the pad.

Standing and Raising Slings- with loop and lock

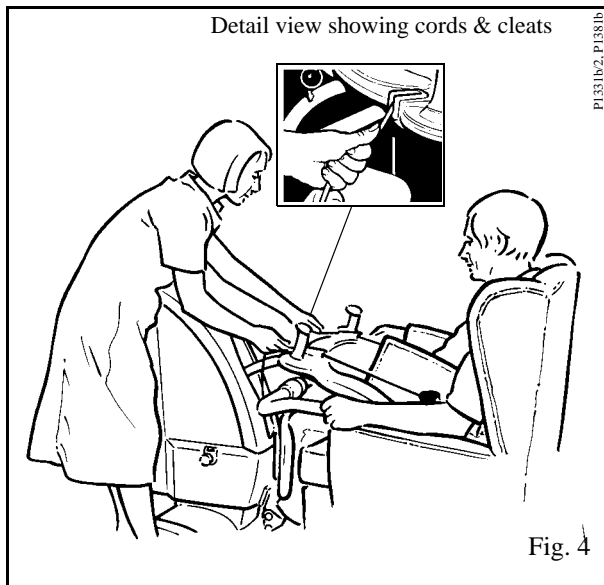

- **Note:** The patient should be supported by the sling, but not pulled forward too much. (See Fig. 4)

If possible, the patient should then hold on to the Patient Support anus with one or both hands.

The patient is then ready to be lifted.

- **Note:** If the handset button or dual control button is released during lifting or lowering powered motion will stop immediately.

If the patient is able to offer some assistance when standing this may be beneficial to patient confidence and muscular exercise. Encourage the patient to assist all he/she can to rise from the chair and/or steady themselves.

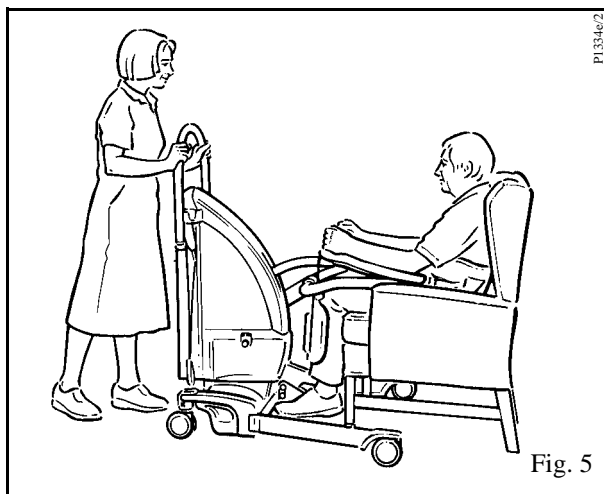

Operate the lift button on the handset or dual control panel to raise the patient to a suitable and comfortable height for the particular function, e.g. transportation, toileting with commode, etc. (See Fig. 6)

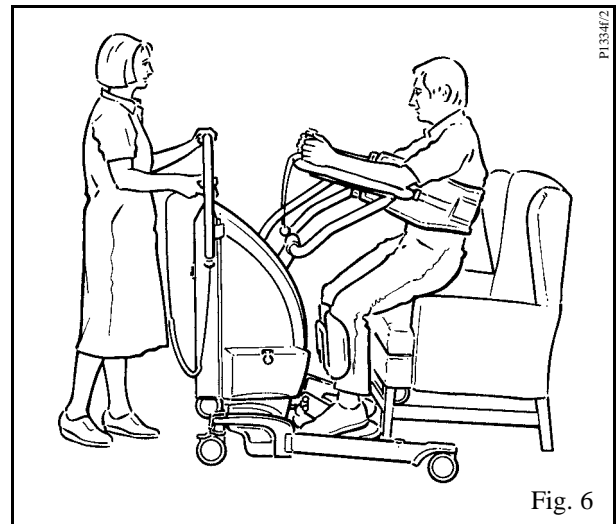

Warning: Always check that the sling adjustment cords are fully in position and locked before and during the commencement of the lifting cycle, and in tension as the patient's weight is gradually taken up.

- **Note:** If the patient can stand sufficiently well and lock his/her knees in the normal way when fully raised, their knees will come away from the Proactive Pad TM and he/she will be able to lean back into the sling.

Patients who can only hold on with one hand (those who have suffered a "stroke", for example) may still be lifted using an active lifter. The patient may just rest the unusable arm on the Arc-Rest or hold it across their chest, and rest their elbow on the end of the Arc-Rest, while their useable hand holds the handgrip in the normal way.

Release the brakes, and transfer the patient to new position, i.e., toilet, wheelchair, chair, bed, etc.

- **Note:** Transportation should be done with the chassis legs closed, it is easier through doorways etc.

While the patient is raised, make any necessary adjustments to clothing, incontinence pads etc., before lowering again. Lower the patient carefully

Standing and Raising Slings- with loop and lock

using the control handset or dual control panel.

When the patient is seated in the new position, and you wish to remove the sling. Pull each cord up from the locking cleats and slacken the cords sufficiently to release the Loop Lock™ fitting, and then remove the cords from the sling.

Pull apart the "Velcro" fastening to remove the support strap.

Remove the sling from the patient. Remove the lower leg straps if they have been applied.



Warning: If the patient lacks sitting balance and has been returned to sit on the side of the bed a second attendant may be needed to support the patient while the sling is being removed.

Boss Slings

The *Bos Sling* has been designed for use in conjunction with the normal *Encore* standing sling range. Its purpose is to offer more support by pulling the patients buttocks inwards towards the hoist thrusting the hips forwards into Extension. "Patients will hence be standing in a more upright position which is more favourable for rehabilitation."

The sling can also be used on the *Encore* for walking practice with patients who have been correctly advised by a physiotherapist and have progressed from using the recommended *Encore* walking sling in the initial stages.

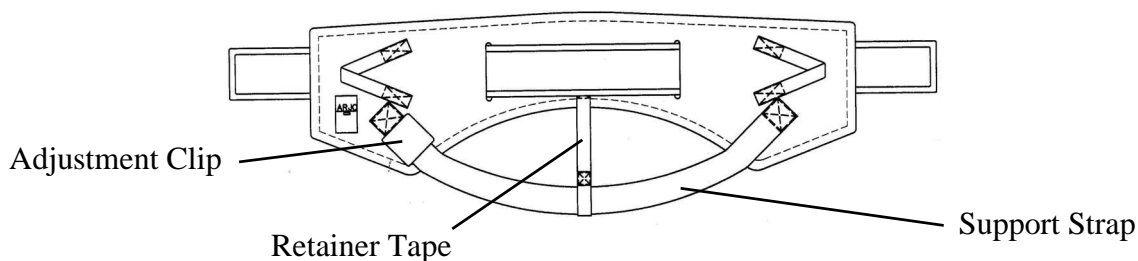

KKA5370-S	KKA5370-M	KKA5370-L	KKA5370-XL
------------------	------------------	------------------	-------------------

Attaching the sling

Attach the *Bos Sling* exactly as you would the standard *Encore* sling. Tighten the waist belt so the sling is held in place by itself and gives you two free hands to position the support strap.



The support strap will be hanging down at the back of the patient under the sling. Working from the side and the front of the patient lean them forward and position the strap down towards the patient's coccyx between the buttocks and the chair. You may need to swap sides if there is no access to the back of the patient due to the chair being up against the wall.

Kneeling in front of the patient grasp the left and right ends of the strap which you have positioned previously and slide the strap under the patient in small stages. Sliding one side first and then following with the other is the preferred method.



Before Lifting

Before lifting the patient the adjustment clip can be opened and any slack taken up. Always check the clip is closed before lifting.

Boss Slings

Re-adjusting the support strap



If the *Bos Sling* requires adjusting this is best carried out while the patient is sitting. The support strap can be adjusted during the standing position but extra help is required to hold the patient safely while the strap adjustment is being carried out.



The retainer tape holds the support strap in place but allows it to be adjusted and pulled further under patients who require more support. It also prevents the support strap from being positioned too far under and taking all the patients weight.

Walking Practice

When the patient is in the standing position, loosen the support strap as shown. This will give the patient freedom of movement and allow the *Bos Sling* to rest below the buttocks, ready to offer more support if the patient falls.

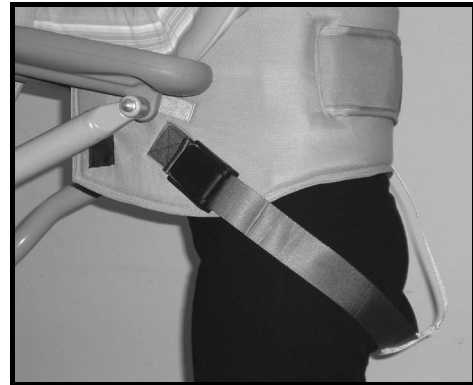

If the patient should fall, the support strap and kneepad will offer more support to the patient until a chair can be placed under them.



Refer to the *Encore* Operating Instructions for a full explanation of walking practice.

The *Bos Sling* can also be used on the *Chorus* with its Loop 'n' Lock system for standing only.

Removing the Bos Sling.

After lowering the patient undo the loop and lock as you would with the standard sling. Slacken off the support strap, slide the strap in stages away from the patient and remove.

Product Care

Refer to *Slings* document MAX01520.INT.

Walking Jacket

The Arjo walking Jacket was created to enable therapists and carers to effortlessly aid patients with standing, stepping and walking practice. The Arjo walking jacket was designed to work in conjunction with the Bianca/Bravo lifting system and the mobile Arjo Maximove/Opera.



Initially, select a Walking Jacket from the range of sizes to correspond with the weight, height and proportions of the patient. The jacket should fit firmly but comfortably around the patient. If it is obvious that an incorrect size jacket has been first selected, do not continue, but change it for the correct size.

Identify the front of the jacket (front has two loops positioned at waist level). Place the jacket over the head of the patient; ensure the rear section is well down the patient's back.

Bring the leg sections of the jacket through under the patient's legs (see Fig. 1) ensuring the sections are not twisted. Do not connect the leg sections yet.

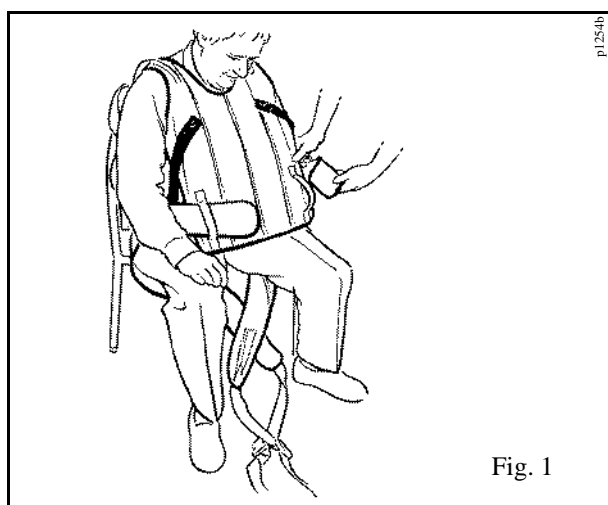

Ensure all straps are not twisted before connecting the buckles. The jacket attachment straps have

variable position loops all colored differently so it is easy to identify the same loop on either side. The same colored loop must always be used on both sides. The loop to be selected will depend on two factors, the type of Arjo lift being used for the support and the height of the patient.

The next sequence of operations depends on which type of Arjo lift is being used for the supportive function.

Pass the waist straps around the patient ensure they are not twisted and push them through the loops (see Fig. 1) tighten the straps so as to be supportive but not over tight, press the "Velcro" patches together to fasten.

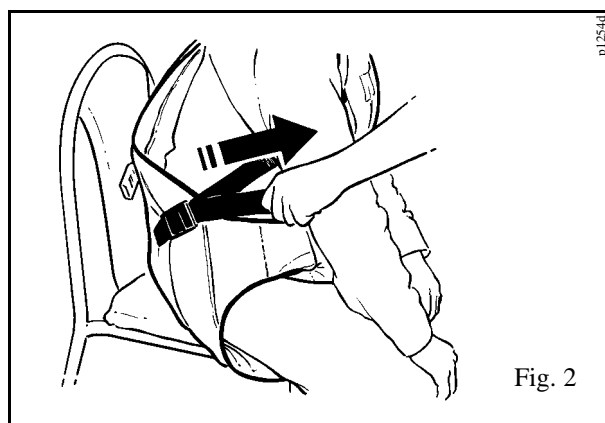

Fasten each chest strap (colored black) by connecting the black buckles and adjust by pulling the loose end of the strap until tight but not restrictive. (See Fig. 2).

Take the leg straps (colored white) and connect the buckles (left strap to left buckle, right strap to right buckle.) Do not cross the body with the leg straps.

Adjust the straps by pulling the loose end of the strap, again tight but not restrictive. (See Fig. 3).

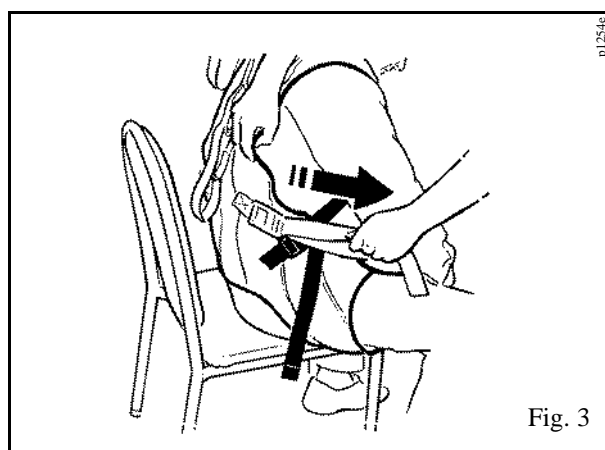

Tailor Made Slings

Sometimes a patient's safety and comfort can only be assured by the provision of a customised sling.

Although Arjo's sling range covers most patient's needs, there are individual factors- height, body weight distribution; physical condition- that may mean a customised sling is the right solution.

Arjo have developed Tailor made slings as a solution to this problem and we now have long experience of making slings with specific patients in mind.

As well as patient specific adaptations, there are also options to add belts, straps or pull handles to make positioning and handling of specific patients easier.

For more information on Arjo Tailor made sling options, please refer to the 'Tailor made Slings from Arjo' document, available from Global Marketing.



Clip Slings

STANDARD SLING

Order ref	Size
MAA2000-XS	Extra Small
MAA2000-S	Small
MAA2000-M	Medium
MAA2000-L	Large
MAA2000-LL	Large Large
MAA2000-XL	Extra Large
MAV2908	Extra Extra Large

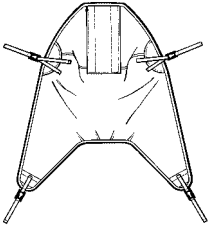

MESH SLING

Order ref	Size
MAA4060-XS	Extra Small
MAA4060-S	Small
MAA4060-M	Medium
MAA4060-L	Large
MAA4060-LL	Large Large
MAA4060-XL	Extra Large
MAV2994	Extra Extra Large

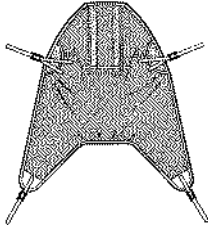

EXTENDED LEG SLING + 100MM

Order ref	Size
MAV4841	Small
MAA4100-M	Medium
MAA4100-L	Large
MAA4100-XL	Extra Large
MAA4100-XXL	Extra Extra Large

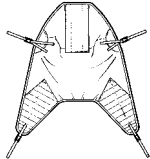

EXTENDED LEG UNPADDED SLING + 100MM

Order ref	Size
MAA2100-M	Medium
MAA2100-L	Large
MAA2100-XL	Extra Large

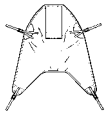

RIGHT LEG SINGLE AMPUTEE SLING

Order ref	Size
MAV4826	Medium
MAV4662	Large
MAV5767	Large Large
MAV4820	Extra Large

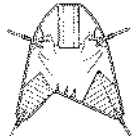

DOUBLE AMPUTEE SLING

Order ref	Size
MAA2090-XS	Extra Small
MAA2090-S	Small
MAA2090-M	Medium
MAA2090-L	Large
MAA2090-XL	Extra Large

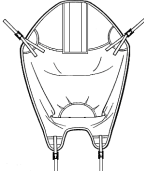

DOUBLE AMPUTEE MESH SLING

Order ref	Size
MAV2596	Small
MAV2597	Medium
MAV2598	Large
MAV2599	Extra Large



PADDED SLING

Order ref	Size
MAA4000-XS	Extra Small
MAA4000-S	Small
MAA4000-M	Medium
MAA4000-L	Large
MAA4000-LL	Large Large
MAA4000-XL	Extra Large
MAV4834	Extra Extra Large

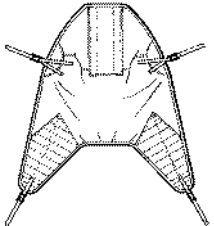

TOILET SLING WITH HEAD SUPPORT

Order ref	Size
MAA4031-XS	Extra Small
MAA4031-S	Small
MAA4031-M	Medium
MAA4031-L	Large
MAA4031-LL	Large Large
MAA4031-XL	Extra Large

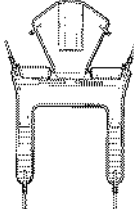

AMPUTEE SLING WITH VELCRO FLAP

Order ref	Size
MAV4828	Extra Small
MAV4830	Small
MAV4818	Medium
MAV4673	Large
MAV5766	Large Large
MAV5050	Extra Large

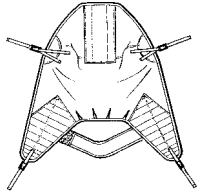

EXTENDED LEG MESH SLING + 100MM

Order ref	Size
MAA4160-M	Small
MAA4160-L	Medium
MAA4160-XL	Extra Large

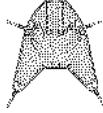

LEFT LEG SINGLE AMPUTEE SLING

Order ref	Size
MAV4873	Medium
MAV4509	Large
MAV5768	Large Large
MAV4867	Extra Large

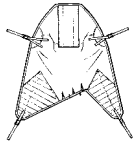

DOUBLE AMPUTEE SLING WITH COMMODO APERTURE

Order ref	Size
MAV7121	Small
MAV2630	Medium
MAV2632	Large
MAV2633	Extra Large
MAV7122	Extra Extra Large

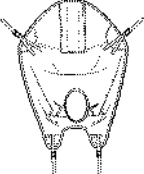

DOUBLE AMPUTEE MESH WITH COMMODO SLING

Order ref	Size
MAV7136	Small
MAV7040	Medium
MAV7076	Large
MAV7137	Extra Large



Loop Slings

LOOP SLING WITH HEAD SUPPORT

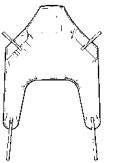
Order ref	Size	
MAA1211-S	Small	
MAA1211-M	Medium	
MAA1211-L	Large	
MAA1211-XL	Extra Large	

LOOP SLING WITHOUT HEAD SUPPORT

Order ref	Size	
MAA1210-S	Small	
MAA1210-M	Medium	
MAA1210-L	Large	
MAA1210-XL	Extra Large	

LOOP TOILET SLING

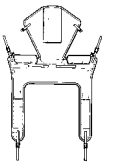
Order ref	Size	
MAV1848	Small	
MAV1849	Medium	
MAV1850	Large	
MAV1851	Extra Large	

RIGHT LEG SINGLE LOOP AMPUTEE SLING

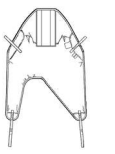
Order ref	Size	
MAV1857	Small	
MAV1858	Medium	
MAV1859	Large	
MAV1861	Extra Large	

RIGHT LEG SINGLE LOOP PADDED AMPUTEE SLING

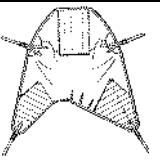
Order ref	Size	
MAV1842	Small	
MAV1843	Medium	
MAV1844	Large	
MAV1846	Extra Large	

PADDED LOOP SLING WITH HEAD SUPPORT

Order ref	Size	
MAV1816	Small	
MAV1817	Medium	
MAV1818	Large	
MAV1819	Extra Large	

LOOP MESH SLING

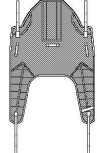
Order ref	Size	
MAA1221-S	Small	
MAA1221-M	Medium	
MAA1221-L	Large	
MAA1221-XL	Extra Large	

LOOP AMPUTEE SLING

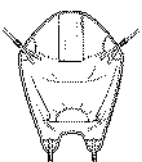
Order ref	Size	
MAV7123	Small	
MAV7124	Medium	
MAV7046	Large	
MAV7125	Extra Large	
MAV7126	Extra Extra Large	

LEFT LEG SINGLE LOOP AMPUTEE SLING

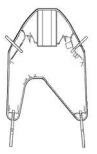
Order ref	Size	
MAV1852	Small	
MAV1853	Medium	
MAV1854	Large	
MAV1866	Extra Large	

LEFT LEG SINGLE LOOP PADDED AMPUTEE SLING

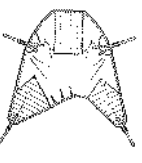
Order ref	Size	
MAV1882	Small	
MAV1883	Medium	
MAV1884	Large	
MAV1886	Extra Large	

Bariatric Slings

BARIATRIC LOOP PADDED SLING SWL 409KG/900LBS

Order ref	Size	
MAV1836	Medium	
MAV1837	Large	
MAV1839	X Large	
MAV1840	Extra Extra Large	

BARIATRIC LOOP BASIC PADDED SLING SWL 409KG/900LBS

Order ref	Size	
MAV1990	Medium	
MAV1991	Large	
MAV1992	Extra Large	
MAV1993	Extra Extra Large	

BARIATRIC LOOP DIVIDED LEG HAMMOCK SLING SWL 409KG/900LBS

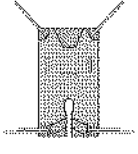
Order ref	Size	
MAV1895	Medium	
MAV1896	Large	
MAV1897	X Large	
MAV1898	Extra Extra Large	

BARIATRIC LOOP BASIC HAMMOCK SLING SWL 409KG/900LBS

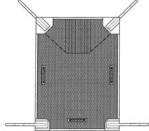
Order ref	Size	
MAV1890	Medium	
MAV1891	Large	
MAV1892	Extra Large	
MAV1893	Extra Extra Large	

Warnings and Safety Instructions



Warning: It is essential to familiarise yourself with the correct method of use before any attempt is made to lift a patient.



Warning: Thoroughly inspect the sling before any attempt is made to use it. If the sling is faulty in anyway DO NOT USE.



Warning: Always carefully assess the patient for the correct size of sling, as size coding differs between sling manufacturers.

- Before attaching the sling ensure the spreader bar is rotated into position so the eventual lift will resemble fig 1.



Warning: Always check that the sling attachment loops/clips are fully in position before and during the commencement of the lifting cycle, and in tension as the patient's weight is gradually taken up.



Warning: Check that all four points of the sling are securely connected before lifting.

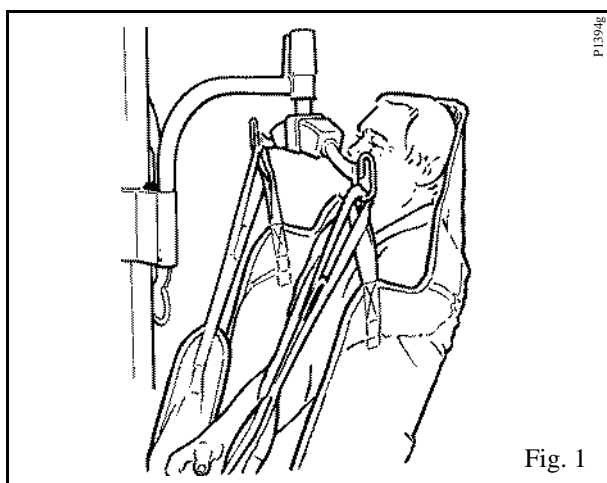

- When attaching a loop sling to the 2 point spreader bar always ensure the sling attachment loops are positioned correctly into the retaining hooks as shown in fig. 2.

- Check all the loops are securely attached before lifting.

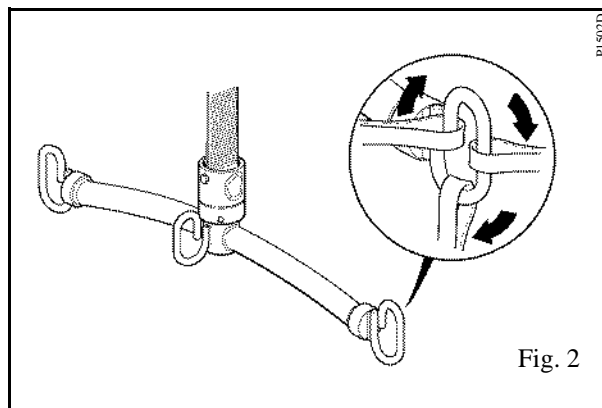

- Only when the patient's body weight is fully supported by the bed, may the sling leg connection clips be detached, followed by the shoulder connections.
- Transportation of a patient should always be done with the chassis legs parallel (closed) manoeuvrability will be easier, especially through doorways, with the chassis legs closed. The patient should be positioned facing the attendant. Apply the chassis brakes if leaving the patient unattended.
- The expected operational life for fabric slings and fabric stretchers is approximately 2 years from date of manufacture. This life expectancy only applies if the slings and stretchers have been cleaned, maintained and inspected in accordance with the 'ARJO Sling Information' documents, the 'Operating and Product Care Instructions' and the 'Preventive Maintenance Schedule'.

Flites

- Do not smoke or allow naked flames in the vicinity of sling.
- ARJO Flites must not be used to support a patient whilst bathing or showering.

Notes

Notes

Notes
