

journey so lite scooter

PRODUCT MANUAL



TABLE OF CONTENTS

1. Preface	3
2. Dos and Don'ts	4
2.1 Inspection upon delivery	4
2.2 Explanation of symbols	4
2.3 Safety instructions	4
2.4 Intended use	7
2.5 Electromagnetic interference (EMI)	7
2.6 Transporting the scooter	9
3. Product Description	9
3.1 Product feature	9
3.2 Components	10
3.3 Technical specifications	11
4. Installation and Adjustment	12
4.1 Unfolding and folding the scooter	12
4.2 Mounting and removing the battery	14
4.3 Adjusting the backrest	14
5. Use	15
5.1 Precautions before operation	15
5.2 Understand the operation interface	15
5.3 Tires	19
5.4 Anti-tip wheel	20
5.5 Transfer in or out the scooter	20
5.6 Correct position in scooter	20
5.7 Driving	20
5.8 The first driving	21
5.9 Driving on a slope	23
5.10 Driving over the obstacles	24
5.11 Transport by car	24
6. Lithium Battery and Charging	25
6.1 Lithium battery	25
6.2 Battery Charging	26
6.3 Charger	27
7. Maintenance	28
7.1 Cleaning the scooter	28
7.2 Disinfecting the scooter	28
7.3 Instructions for reuse	29
7.4 Inspection, service and maintenance	29
7.5 Reuse after a hiatus	30
7.6 End-of-use disposal	30
8. Transportation and Storage	31
8.1 Transportation and storage	31
9. Concerns and Solutions	31
9.1 Basic Troubleshooting	31
9.2 Scooter Controller Internal Diagnostics	32
10. Warranty	33
10.1 So Lite™ S1 12-Month Limited Warranty	33
10.2 Limitations and Exclusions:	33

1. Preface

Welcome!

First, we thank you for putting your trust in us by selecting the outstanding So Lite™ S1 scooter.

This product manual will help you get acquainted with the operation of this scooter and present you with some invaluable safety tips. The use and care instructions included here also contain essential information for using and maintaining this scooter. This manual reflects the latest development of the product, but please understand that in case of product changes and improvement, the manual will be updated and changed along with the product.

Your safety is most important to us, so before you use the scooter, please read this instruction manual carefully. It will play an important role in the safe operation of your scooter. Under normal use and with correct maintenance performed according to this manual, the manufacturer-provided warranty service will remain in effect. (See Warranty information on page 33). The manufacturer is not liable for damages caused by the lack of service or improper service, or as a result of failure to follow the instructions in the manual.

With the improvement of the scooter design as this manual was in progress, some illustrations and pictures herein do not exactly match the scooter you purchased; however, it is important to have these instructions available for new owners, and the manufacturer reserves the right to improve both the products and the manual and introduce changes as they occur.

We hope your So Lite™ S1 scooter will bring added convenience and joy into your life. We also look forward to your valuable suggestions on the quality and after-sales service of our scooters.

If you have any questions, call us at our free toll-free number:

1-800-958-8324

2. Dos and Don'ts

2.1 Inspection upon delivery

Please check to see that the main frame and accessories (as listed below) are all there. If any parts are missing or damaged, please contact the dealer immediately.

- Scooter: 1 piece
- Armrest: 1 pair
- Product manual: 1 piece

2.2 Explanation of symbols

	Warning	Indicates that personal injury may result from misuse
	Caution	Indicates that personal injury or damage to scooter may result from misuse
	Mandatory	Indicates instruction must be followed
	Prohibited	Indicates something specific is not allowed
		Process to apply or release the brake
		Warning: Take care not to pinch hands or fingers
		Reading the product manual
		The max load capacity

2.3 Safety instructions

Warning!

Mandatory! Please read this manual carefully before use. To ensure your safety, confirm that all parts have arrived and are in good condition.

Prohibit! Do not expose the scooter's electrical system to moisture (such as rain, snow, fog, etc.) at any time. Do not wash the scooter as moisture will damage the electrical system. Should the system get wet, wait for it to dry, and then confirm that it is working properly with no evident damage before driving again.

- ⊘ **Prohibit!** Do not drive the scooter in bad weather conditions, such as rain, snow, fog, strong winds, temperatures below 14°F or above 104°F, etc. Driving the scooter under these adverse conditions may damage the electrical system and cause control failure.
- ⊘ **Prohibit!** Do not drive in deserts, on beaches or on roads that are muddy, frozen, graveled or bumpy, etc., so as not to affect the performance of the scooter and to avoid accidents and personal injury.
- ⊘ **Prohibit!** Users are strictly prohibited from modifying the scooter without the consent of the technician. In the event of an accident involving a scooter with unauthorized modifications, the manufacturer will not be responsible and damages will not be covered under warranty.
- ⊘ **Prohibit!** Please do not extend arms or legs or lean to the side when driving (especially on bumpy roads); otherwise, the stability of the scooter may be affected.
- ⚠ **Caution!** Be careful when driving and parking on sloped or hilly roads.
- ⚠ **Caution!** Be especially careful of vehicles and pedestrians when driving at night and in rainy weather.
- ⚠ **Caution!** For the safety of you and others, do not give or lend your scooter to others who have never used or are unfamiliar it—or to anyone who might have problems operating it. That might include minors, the mentally handicapped or visually impaired, pregnant women or others temporarily or permanently not suited for handling an electric scooter.
- ⓘ **Mandatory!** This scooter is intended to be a means of transportation and convenience for adults with mobility issues. While a driver's license is not required under most traffic laws, the scooter operator must obey the same traffic rules as a pedestrian.
- ⓘ **Mandatory!** For safety, do not drive a scooter when under the influence of alcohol, drugs or when fatigued.
- ⓘ **Mandatory!** If you are taking medication, check with your doctor to find out if the medication could adversely affect the safe operation of your scooter.
- ⓘ **Mandatory!** Before operating the scooter for the first time, please familiarize yourself with the functions of the scooter. In a location with few people and solid ground, practice moving forward, accelerating, decelerating, stopping, reversing, turning, moving uphill and down, and other operations that you'll be regularly performing. After mastering the scooter operation, you'll be ready for your first "trip."
- ⓘ **Mandatory!** During the learning process, to ensure safety, it would be good to be accompanied by someone close at hand who is familiar with the scooter.

- ⓘ **Mandatory!** Please do a regular check of the scooter to make sure the brakes are sensitive, the performance is normal, the parts that fold and unfold are securely in place, and the battery is properly charged.
- ⊘ **Prohibit!** Do not remove the anti-tip wheel.
- ⊘ **Prohibit!** The scooter cannot be used for carrying or towing goods.
- ⊘ **Prohibit!** The user needs to sit on the scooter seat and hold both handles in order to operate the unit.
- ⊘ **Prohibit!** To avoid rollover, don't zigzag when driving—and don't make sharp turns at high speed.
- ⓘ **Mandatory!** Please keep your attention level high at all times. Slow down on uneven or soft surfaces (like grass), at corners, on busy streets, and at shopping centers, parks or other crowded places.
- ⊘ **Prohibit!** Do not use wireless communication devices such as mobile phones while driving. Instead, park the scooter in a safe place and turn off its power before using your phone, etc.
- ⓘ **Mandatory!** When moving in reverse, pay attention to surrounding road conditions, vehicles and nearby pedestrians; then back up slowly.
- ⊘ **Prohibit!** When exiting from an elevator door, please drive slowly. It is illegal and forbidden to take a scooter onto an escalator.
- ⊘ **Prohibit!** When going up and down a slope, please give high attention to driving straight (no zigzagging) and maintaining a low speed. Do not forcibly cross a slope that exceeds the allowable gradient.
- ⊘ **Prohibit!** Do not force the scooter over obstacles or steps over 2 inches high. Such obstacles may prevent the scooter from moving forward, so brake immediately.
- ⊘ **Prohibit!** Do not cross a trench more than 4 inches wide, as too large a gap may stop the scooter from moving forward. Brake immediately.
- ⊘ **Prohibit!** When crossing intersections, please obey traffic rules and traffic lights. At railway crossings, stop, listen and observe first; then move slowly at right angles across the tracks to prevent the scooter wheels from slipping into the track grooves.
- ⊘ **Prohibit!** Do not intentionally switch the scooter power on and off frequently, and do not frequently start and stop the scooter unnecessarily.
- ⊘ **Prohibit!** Do not allow minors to play with the switches and throttle lever of the scooter.

- ⊘ **Prohibit!** Do not overload. The max loading capacity is 275 lb—driver only!
- ⊘ **Prohibit!** Do not disassemble the battery, motor and controller yourself. For replacement, please purchase original parts from an authorized dealer. (Scooters that have been modified or that use non-original parts will not be covered under warranty).

2.4 Intended use

This scooter is intended for adults with mobility issues. It is intended for one-person use, driver only, with a total weight not to exceed the 275 max wt capacity.

The persons under the age of 16, mentally handicapped, pregnant women and other incapable persons who cannot use scooter are prohibited from using this product.

Limitation may include but not limited to the following:



- **Hemiplegic or paraplegic**
- **Mental disorder**
- **Visually impaired**

2.5 Electromagnetic interference (EMI)

This section describes the daily use of the mobility scooter, with instructions to inform and aid scooter users and specialist dealers.

Please note that it is possible for sources of electromagnetic waves (such as cell phones) to create interference with scooter performance. Conversely, the scooter's own electronics could affect the operation of nearby electric appliances and electronics as well.

To reduce the effect of electromagnetic sources of interference, please read the following warnings:

-  **WARNING!** The scooter might disturb the operation of devices in its environment that emit electromagnetic waves.
-  **WARNING!** The driving performance of the scooter can be influenced by electromagnetic fields (e.g. electricity generators or high power sources).
-  **WARNING!** Avoid using any portable TV or radio in the immediate environment of your scooter when the scooter is turned on.

 **WARNING!** Avoid using any transmitter-receiver or cell phone in the immediate environment of your scooter for as long as the scooter is turned on.

 **WARNING!** Check the area for transmitter towers and avoid using the scooter close to them.

 **WARNING!** If involuntary scooter movements or unexpected braking occurs, turn off the scooter as soon as it is safe to do so.

Interfering electromagnetic fields may have a negative effect on the scooter's electronic systems. These can include:

- Disengagement of the engine brake
- Uncontrollable behavior by the scooter
- Unintentional steering movements

In the presence of very strong or enduring interfering fields, the electronic systems could even break down entirely or suffer permanent damage.

Possible sources of radiation include:

- Portable receiver and transmitter installations (receiver and transmitter with fixed antenna mounted directly on the transmitting unit)
- Transmitting and receiving sets
- Portable TV, radio and navigation devices
- Other personal transmitting devices
- Mobile medium-range transmitting and receiving devices (e.g. car antennas, with the antenna mounted on the outside of the vehicle)
- Fixed transmitting and receiving sets
- Fixed mobile transmitting and receiving devices
- Fixed radio, TV and navigation systems

Other home devices such as CD players, notebooks, cordless phones, AM/FM radios, electric shavers and hair dryers, so far as we know, will have no negative impact on the scooter, provided they function properly, with cabling in satisfactory condition. Please follow the operating instructions accompanying such electric appliances and instruments to ensure trouble-free operation of your scooter.

1. When the scooter is turned on, do not operate hand-held transceivers-receivers, such as citizens band (CB) radios, or turn on personal communication devices, such as cellular phones.

2. Please be aware of nearby transmitters, such as radio or TV stations, and try to avoid driving the scooter close to them.

3. If unintended movement or brake release occurs, turn the scooter OFF as soon as it is safe.

4. Please be aware that adding accessories or components or modifying the scooter may make it more susceptible to EMI. (Note: There is no easy way to evaluate the effect of such additions and modifications on the overall EMI resistance of the scooter.)

2.6 Transporting the scooter

The first step in preparing to transport the scooter is to (1) make sure the brake handle is released so you can roll or drive the scooter to a vehicle for transport. (2) Switch the scooter off. (3) Fold the scooter. (4) Lift it into transporting vehicle.

3. Product Description

3.1 Product feature

3.1.1 This product is designed to be light, compact and comfortable. The tiller can be adjusted back and forth according to individual comfort needs. The scooter can be folded manually, and it can be pulled along easily when folded. Equipped with a high performance brushless controller, the scooter offers great flexibility so that users can operate it easily and safely. The battery is removable for easy charging.

3.1.2 The waterproof level is IPX4; the degree of protection against electric shock is Class B.

3.1.3 The rear geared motor is used to ensure reliable and stable riding.

3.1.4 The ergonomic seat design provides hours of comfort for drivers.

3.1.5 This product is suitable for use indoors and outdoors on flat roads near buildings.

3.2 Components

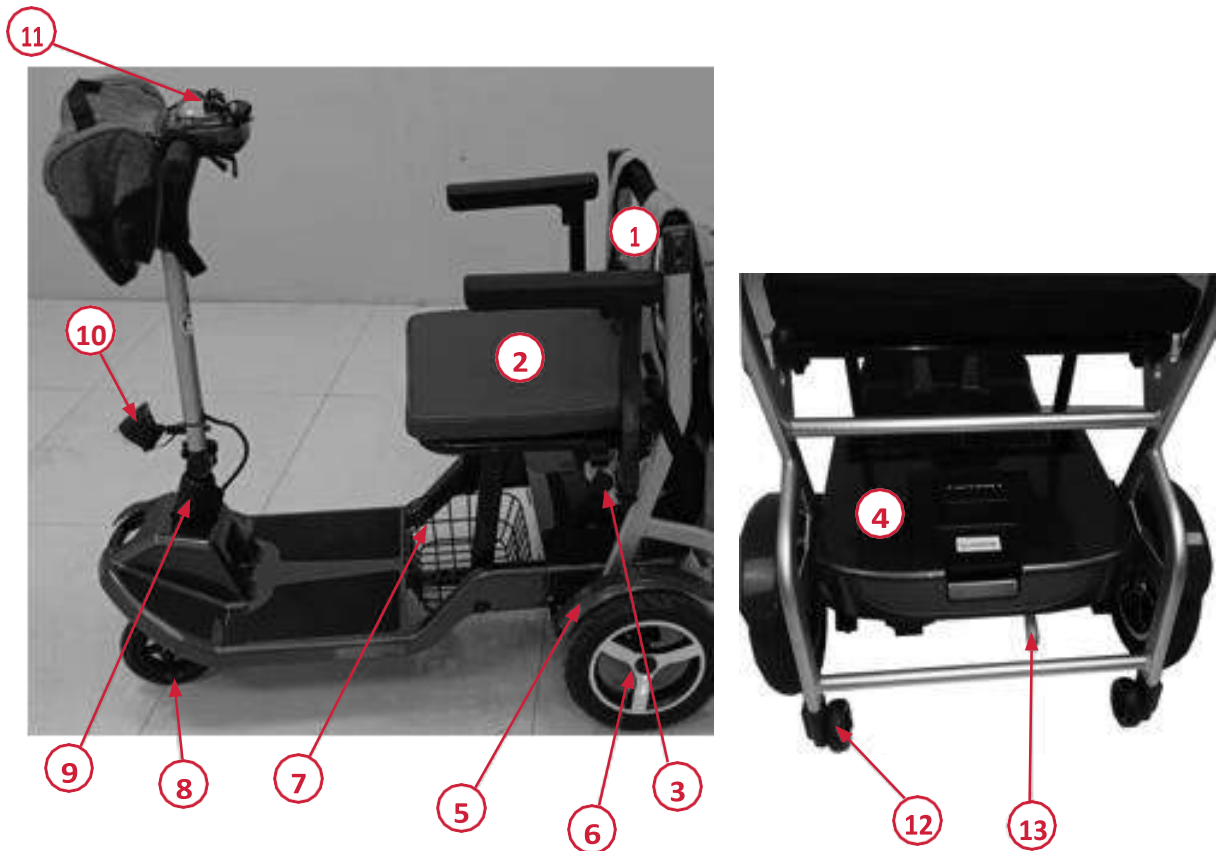

1. SeatbackCushion
2. Seat Base Cushion
3. Seat Folding Knob
4. Battery Box
5. RearMud Guard
6. Rear Wheel
7. Storage Basket

8. Front wheel
9. Tiller Adjuster
10. LED Light
11. Control Panel
12. Anti-Tip Wheel
13. Freewheel Lever

Your scooter is equipped with a number of elements and parts. You should know these before using the scooter. Designs and specifications may change without prior notice.

3.3 Technical specifications

Model Reference	08474
Speed (Max)	5 mph (8 km/h)
Battery	1 x 24V 10Ah Lithium
User Weight (Max)	275 lbs. (125kg)
Total Weight w/o Batteries	40.8 lbs. (18.5kg)
Total Weight with Batteries	44.5 lbs. (20.2kg)
Overall Length	1000 mm (39.5 in.)
Overall Width	550 mm (21.5 in.)
Overall Height	940 mm (37 in.)
Folded Length	1000 mm (39 in.)
Folded Width	550 mm (21 in.)
Folded Height	430 mm (17 in.)
Climbing Gradient (Max)	8 Degrees
Turning Radius (Min)	1150 mm (45 in.)
Ground Clearance (Max Mid Frame)	105 mm (4 in.)
Seat Type	Folding with removable seat covers
Seat Width	430 mm (17 in.)
Seat Height	370 mm (18 in.)
Front Tire	150 mm (6 in.) Solid Puncture
Rear Tire	250 mm (10 in.)
Lights	Front LED
Basket	Metal under seat
Tiller Type	Straight Handle
Charger	2 Amp
Charging Type	Battery Box that can be off board
Brake	Automatic Electromagnetic

REMARK: Manufacturer reserves their right to modify the specification if necessary. Measurement tolerance ± 0.6 inch/ 2Lbs/ 1.5°.

The final specification is subject to individual scooter you purchased from dealer.

4. Installation and adjustment

The scooter is quick and easy to assemble and to fold, using the following steps:

4.1 Unfolding and folding the scooter

STEP 1 Unfold the Scooter

To unfold the scooter, first place the scooter with all wheels on the ground as shown [Fig 4.1.1]. Loosen the tiller adjuster knob [Fig 4.1.2] and lift the tiller into drive position [Fig 4.1.3]. Re-tighten tiller adjuster knob, making sure you have securely tightened the tiller into position.

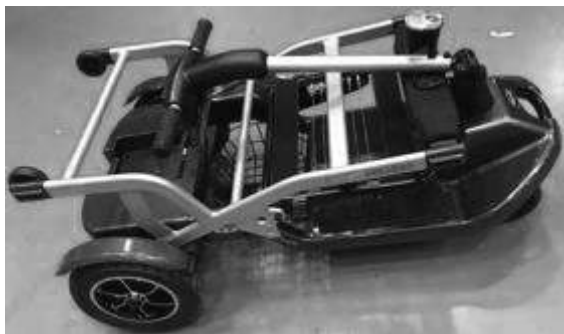

[Fig 4.1.1]



[Fig 4.1.2]



[Fig 4.1.3]

⚠ WARNING! Failure to tighten the tiller adjuster knob securely could result in user losing control of the scooter.

STEP 2 Unfold the seat

You are now ready to unfold the seat. To do this, simply lift up the seatback into the driving position. You should hear and feel the fold knob click into the lock position. Check that the seat fold knob is securely locked in position as shown [Fig 4.1.4]. (The fold knob is positioned on the left-hand side of the scooter).

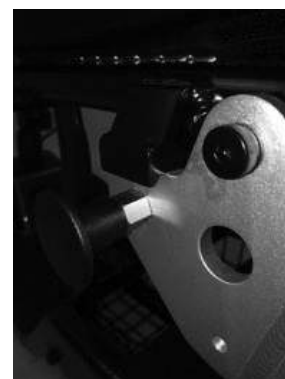

[Fig 4.1.4]

⚠ WARNING! Sitting on the seat without the lock knob correctly in position could result in damage to the scooter, the user or both.

STEP 3 Fold the scooter

To fold the scooter, pull out the fold knob as shown below [Fig 4.1.5]. At the same time gently lower the seatback down into its folded position [Fig 4.1.6].



[Fig 4.1.5]



[Fig 4.1.6]



[Fig 4.1.7]

Now with the seat folded, loosen the tiller adjuster knob and gently lower the tiller into the folded position [Fig 4.1.7]. The tiller handles should be able to rest between the chassis as shown below. Re-tighten the tiller knob to hold the tiller into position. This will then allow you to pull the scooter on its rear tip wheels as shown in Storage and Travel.

STEP 4 Storage and Travel

With the tiller tightened in the folded position, you can now lift the scooter onto its end for both storage and travel. You are now able to pull the scooter along on its rear anti-tip wheels as shown.

⚠ CAUTION! Lifting weight beyond your physical capacity may result in personal injury. Ask for assistance when necessary while disassembling or assembling your scooter.



[Fig 4.1.8]



[Fig 4.1.9]

4.2 Mounting and removing the battery

4.2.1 Insert battery box

To insert the battery box, simply place it into position and push forward as shown below [Fig 4.2.1], gently lowering it into position. Make sure the rubber protector flap remains on top of the battery box.



[Fig 4.2.1]



[Fig 4.2.2]

4.2.2 Remove battery box

To remove the battery box, push the box forward against the sprung connectors and then lift up to release the box [Fig 4.2.2].

Note: When removing and mounting the battery, please make sure that the switch is in the "OFF" state. [Fig 4.2.3]

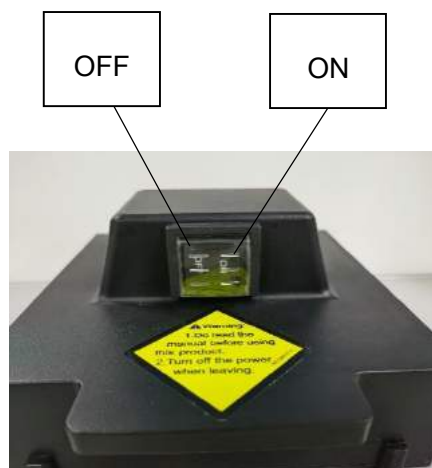

[Fig 4.2.3]

4.3 Adjusting the backrest

4.3.1 Before driving, be sure to adjust the position of the backrest strap. The concave side of the backrest strap should face the back (as shown in the pictures below). Make sure the OFF ON In switch is in the "OFF" position. [Fig 4.2.3]

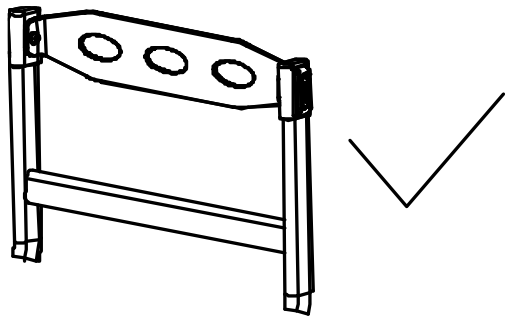

Correct

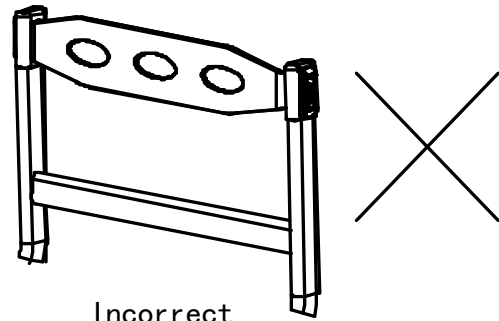

Incorrect

5. Use

Before you use the scooter for the first time, please read this section carefully and fully understand the various precautions, so as to drive the scooter safely, comfortably and freely. If you have any questions, please contact the nearest dealer.

5.1 Precautions before operation

Please read and understand the section "2.3 Safety instructions" before operating scooter.

5.2 Understand the operation interface

5.2.1 Control panel

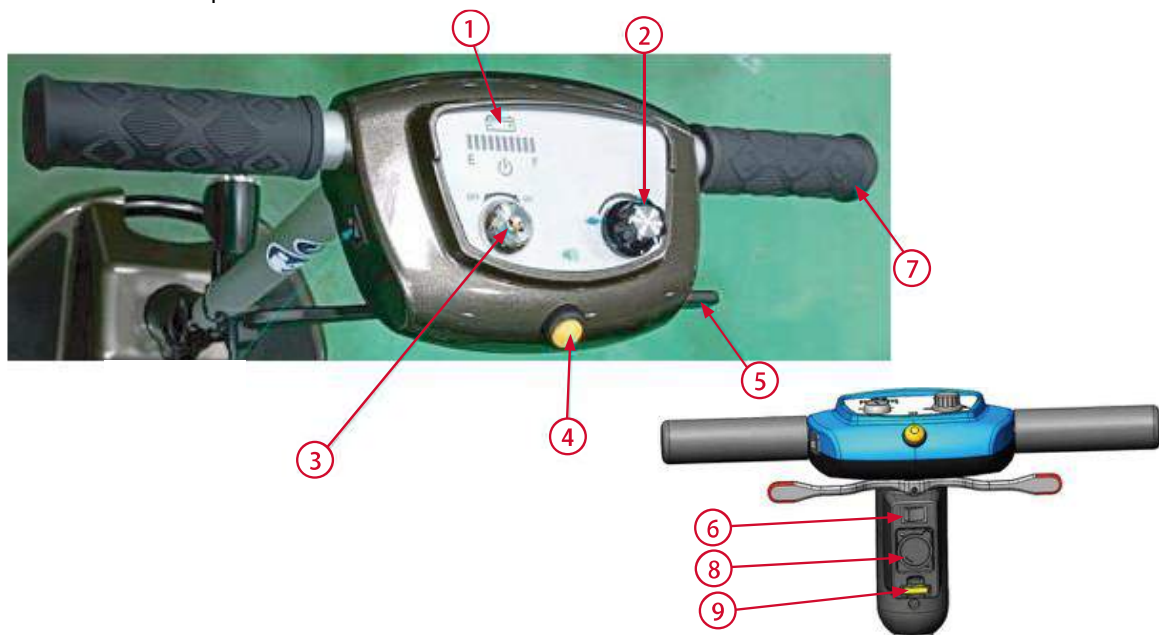

1. Battery indicator/gauge
2. Speed adjustment dial
3. Key switch
4. Horn button
5. Throttle lever forward/back
6. Light switch
7. Tiller handle
8. Charger port
9. Fuse

5.2.2 Battery Indicator/Gauge (1)

Indicates the voltage of the batteries:

- Green — batteries are fully charged.
- Yellow — batteries are half full.
- Red — batteries need charging. Please re-charge them.
- Beeping sound continuing — batteries are out of charge. Please re-charge batteries.

5.2.3 Speed Adjustment Dial (2)

This dial allows you to preselect and limit your scooter's top speed in the range of 0 mph - 5 mph:

- The image of the snail represents the slowest speed setting.
- The image of the hare represents the fastest speed setting.

5.2.4 Key Switch (3)

This turns the scooter power on and off.

- Insert the key into the key switch
- Turn the key clockwise to turn on your scooter's power. The battery indicator will light up to indicate that the power is on.
- Turn the key anti-clockwise to turn off your scooter's power. The battery indicator light will turn off to indicate the power is off.

 **WARNING!** DO NOT turn off the power while driving as doing so will result in a sudden stop that could cause the scooter to tip over.

5.2.5 Horn Button (4)

This button activates a warning horn. Your scooter must be turned on for the horn to be operational. Do not hesitate to use the warning horn when doing so may prevent an accident or injury.

5.2.6 Throttle control lever - Forward/Back (5)

This lever allows you to control the forward and reverse speeds of your scooter, up to the maximum speed you have pre-set using the speed adjustment dial. Place your right hand on the right-hand tiller handle and your left hand on the left hand tiller handle.

To move forward

Use your right thumb to push the right side of the control lever forward. The scooter will then start to move forward.

To move backward

Use your left thumb to push the left side of the throttle control lever forward. The scooter will then start to move backward. Release the lever and allow your scooter to come to a complete stop before pulling the other side of the lever to move in reverse. When the scooter is moving in reverse, the reverse beeper will sound. When the throttle is completely released, it automatically returns to the center "stop" position and engages your scooter's brakes.

5.2.7 Light switch (6)

The light switch turns the front LED light on and off.

5.2.8 Charger port (7)

Charge the battery.

5.2.9 Fuse (8)

When a short circuit occurs, the fuse is blown to protect the safety of all lines. To replace the fuse, first pull the fuse out from the down charging port. Then check whether the fuse was blown or not, [See Picture 1 and Picture 2]. Finally, replace a blown fuse with a new one.

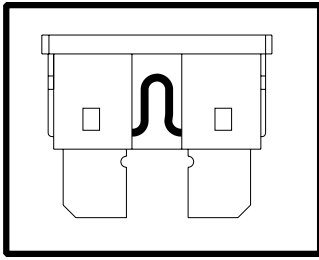

Picture 1

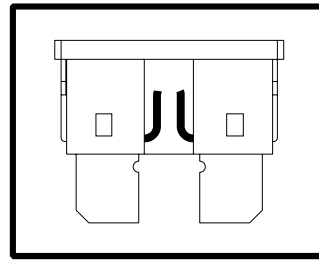

Picture 2

⚠ WARNING! Please make sure the new fuse has the same rating as the old one. The electrical system will be damaged with the wrong rated fuse.

5.2.10 Adjust the tiller assembly

Loosen the knob on the tiller adjuster, hold the tiller lever to a comfortable angle for driving, then tighten the knob.

(1) Tiller Adjuster (2) Knob (3) Tiller Lever

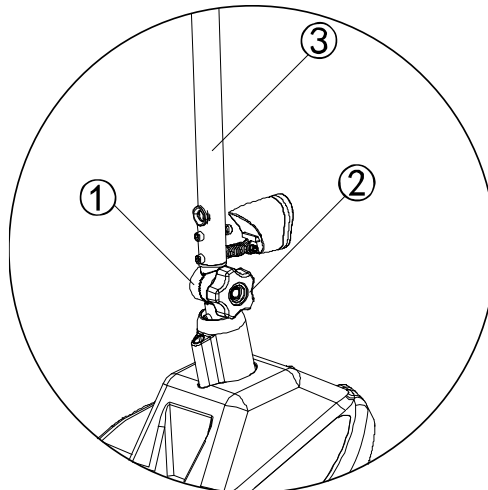

5.2.11 Freewheel lever on the scooter is located on the rear section of the scooter. Before driving, the scooter needs to be put into the drive position. The two positions are:

1. Drive position, which is indicated by "Closed." Pull the lever backward for the position [Fig 5.2.11.1].
2. The freewheel position is indicated by "Open." Push the lever forward for this position [Fig 5.2.11.2].



[Fig 5.2.11.1]



[Fig 5.2.11.2]

⚠ WARNING! Before placing your scooter into or out of freewheel mode, remove the key from the key switch. Never sit on the scooter when it is in freewheel mode. Never put your scooter in freewheel mode on any incline.

⚠ WARNING! When your scooter is in freewheel mode, the braking system is disengaged.

⚠ WARNING! Disengage the drive motors only on a level surface.

⚠ WARNING! Make sure the key is removed from the key switch.

⚠ WARNING! Stand to the side of the scooter to engage or disengage freewheel mode. Never sit on a scooter to do this.

⚠ WARNING! After you have finished pushing your scooter, always return it to the drive mode to lock the brakes.

5.3 Tires

The scooter is equipped with air-free solid PU tires, so you do not need to inflate the tires.

The manufacturer is not responsible for damage to non-genuine original parts. Please contact your specialist dealer for details.

5.4 Anti-tip wheel

The anti-tip wheel assembly is installed on the back of the scooter frame for your safety. It prevents the scooter from tipping backwards when you drive over obstacles that do not exceed the specified maximum height.

5.5 Transfer in or out the scooter

 **WARNING!** Be sure to turn off the power switch and remove the key before getting on or off the scooter.

5.6 Correct position in scooter

Here is some advice for comfortably using a scooter:

5.6.1 Sit with your back as close to the backrest as possible.

5.6.2 Make sure your thighs are level as you sit.

5.7 Driving

5.7.1 Start and drive

5.7.1.1 Check that the manual freewheel lever is closed.

5.7.1.2 Turn the power key switch to the "ON" position first.

5.7.1.3 Check the battery gauge to confirm the amount of remaining power in the battery, and charge the battery when it is low.

5.7.1.4 Adjust the speed knob to the desired speed.

5.7.1.5 Check out and confirm the safety of the surrounding environment and road conditions.

5.7.1.6 The operation of throttle control lever

Slowly turn the right throttle control lever to control the front of the scooter, and turn the left throttle control lever to control the back of the scooter. [NOT SURE ABOUT THIS FRONT AND BACK. COULD MEAN FORWARD MOTION AND REVERSE? WHICH? ALSO END OF NEXT SENTENCE?] Adjust the speed of the scooter according to the forward and backward degree of the throttle control lever.

5.7.1.7 Moving forward: Hold the straight handle, push the right throttle control lever forward with the right thumb, and the scooter will move forward.

5.7.1.8 Moving in reverse: Hold the straight handle, push the left throttle control lever forward with the left thumb, and the scooter will move backward. The horn will sound a warning sound when the scooter is moving in reverse.

5.8 The first driving

 **WARNING!** From the beginning, take control of your scooter, practice in a safe area, and get used to driving it.

 **WARNING!** Do not use both throttle control levers at the same time. Doing so could result in loss of control of the scooter.

 **WARNING!** To avoid risk of injury, do not adjust speed controls while driving.

 **WARNING!** To avoid risk of injury, be sure there are no people or objects behind you when reversing.

- Driving

When sitting on the scooter, start the scooter according to the operating instructions; then hold the handle with both hands and use your fingers to pull the throttle control lever in the desired direction. Please refer to 5.2.6 for details.

- Driving on the sidewalks

The maximum speed on sidewalks depends on local laws and varies from city to city, country to country. Check the local traffic laws where you are.

- Braking

Release the throttle control lever to brake, let it return to the center position, and the scooter will slow down and stop. Please practice the braking distance to get used to the scooter. You need to be able to anticipate how your mobility scooter is going to react as you drive and brake in various situations.

Do not turn off the power switch while driving. To do so will bring about an emergency stop and may result in accident and injury.

- Driving on curves

 **WARNING!** Risk of rollover: Slow down before entering curves or turning corners.

 **WARNING!** Risk of getting stuck: Always keep a sufficient distance from potential obstacles.

 **WARNING!** Risk of rollover: Please don't zigzag or otherwise drive erratically. In corners and bends, use both hands to turn the handlebars in the direction you want to go. The front wheels will turn accordingly and guide the scooter in the proper direction. It is very important that you make sure there is enough space for you to pass through at corners and curves. When there's enough room to do so, prepare for an upcoming narrow turn by starting to make a big curve in advance. That way the scooter won't have to make a sharp turn but can gradually move into the curve less abruptly.

 **WARNING!** Do not turn into 90-degree curves too fast as the rear wheel might contact a curb or other obstacle that could make the scooter unbalanced.

5.8.1 Backwards

 **WARNING!** Control your speed; when backing, drive at as low a speed as possible.

 **WARNING!** Collision hazard - Keep a careful eye behind you as you reverse. Driving backwards requires more attention since it is a left-handed operation and requires a significantly reduced speed compared to that when moving forward. We recommend that you adjust the speed knob to slow the scooter down when reversing.

5.8.2 Going uphill.

 **WARNING!** Take control of your scooter and get used to driving it up hills and slopes.

 **WARNING!** Never leave the scooter on a slope with the manual freewheel lever on.

 **WARNING!** Control your speed, moving as fast as possible on a slope.

 **WARNING!** Do not back up when going uphill.

A proper sitting position when going uphill is to lean forward a bit, being careful not to tip the scooter.

Make sure all wheels are in constant contact with the ground (ramp, driveway, etc.) when on a hill. The scooter is driven by a differential, so the two drive wheels should always be in contact with the ground.

When you are driving on a slope, the battery indicator light may move left and right. This is normal and no cause for concern.

5.8.3 Going downhill

 **WARNING!** Take control of your scooter and practice driving it downhill.

 **WARNING!** Never leave the scooter on a slope with the manual freewheel lever on.

 **WARNING!** Control your speed: Move as slowly as possible on a downhill slope.

 **WARNING!** Risk of rollover: Avoid sharp turns.

A proper sitting position when going downhill is to lean back against the backrest, being careful not to tip the scooter. Too much tilt may cause the wheel to lose contact with the ground and create a risk of rollover.

The scooter's own weight will increase your downhill speed and can cause the scooter to lift on one side and even roll over as you go into a sharp turn or around a corner. Please release the throttle control lever in advance to slow down.

5.9 Driving on a slope

 **WARNING!** Risk of injury: Do not exceed the maximum load of the slope.

 **WARNING!** Risk of injury: Try to avoid steep slopes to prevent any injury or damage.

 **WARNING!** Risk of injury: When the weight of the scooter produces a huge reaction force, an accompanying person may need to push the scooter up the ramp.

 **WARNING!** Risk of injury: Make sure the wheels are high enough to pass ramps. The scooter frame must not touch the ramp.

To use the ramp to cross obstacles, please note the following:

1. Drive at the lowest speed on the ramp.

2. Please refer to the instructions in the section "Your first drive."

5.10 Driving over the obstacles

 **WARNING!** Risk of injury from accidental movement.

- Don't take the scooter on an escalator.
- Never drive over obstacles and steps over 1.57 in.
- Do not drive fast on a slope of more than 5 degrees.
- Do not cross a groove more than 3.9 in wide. Drive in a direction perpendicular to the groove surface.
- Do not tilt the scooter.

Make sure all wheels are in contact with the ground when driving up or down.

 **WARNING!** Risk of damage.

If necessary, do a short acceleration to get over an obstacle. Avoid large reaction forces on your scooter.

 **WARNING!** Never leave your scooter with the manual freewheel lever on while driving, as scooter may roll unexpectedly.





 **Caution:**

- (1) Please turn the power switch to "OFF" when getting on and off.
- (2) When accelerating, do not operate the left and right throttle control levers with both hands at the same time.
- (3) Do not turn the power switch to "OFF" while driving as that may cause sudden braking and a fall.
- (4) Always drive at low speed indoors.
- (5) Please be careful when driving in crowded and heavy traffic areas.
- (6) When reversing, pay attention to the crowds and obstacles behind you.

5.11 Transport by car

This scooter can be folded up and transported in the trunk of a car.

 **WARNING!** Risk of injury: The scooter is not suitable for use as a car seat.

-  **WARNING!** Risk of injury: Remove all loose parts before transport.
-  **WARNING!** Risk of injury-- Risk of injury: During transport, no person or object should be beneath the scooter at any point, and no person or object should ever be sitting or standing on the pedal or standing on the seat during transport.
-  **WARNING!** Risk of injury: Make sure the scooter is secure during transport. In the event of a collision or sudden braking, passenger injuries may be averted or minimized if the scooter is secure.
-  **WARNING!** Risk of injury: Do not put your fingers between the parts of the scooter when folding/unfolding during transport.

6. Lithium battery and charging

Familiarity with lithium batteries and mastering the charging of lithium batteries are conducive to prolonging the service life of the batteries and reducing the occurrence of accidents.

-  **WARNING!** Risk of personal injury or death from fire.

6.1 Lithium battery

6.1.1 If you use the scooter every day, please charge it as soon as possible after each use. Within a charging time of 8-12 hours, the scooter will be ready for the next drive.

6.1.2 If you use the scooter infrequently (once a week or less), charge it at least once a week. Do not charge for more than 12-14 hours.

6.1.3 Lithium batteries must never be near fire, immersed in water, overheated (113°F), subject to violent vibration or collision or exposed to positive and negative short-circuiting.

6.1.4 Please do not charge the lithium battery for too long a time, generally not more than 20 hours.

6.1.5 Do not discard the lithium battery at will. Please contact the dealer or the manufacturer for disposal information.

6.2 Battery charging

6.2.1 After use, carefully check the LED with charging bar on control panel to determine whether it needs to be charged.

6.2.1.1 This electric scooter can be charged with a charger with an output of 29.2Vdc 2A. In order to ensure your safety, please use the charger for electric scooters provided by the manufacturer.

6.2.2 Charging

6.2.2.1 The first charge: It is not necessary to charge the battery for the first time. Start charging when the LED shows red. The same is true for the second and third charge. This prolongs the battery life and eliminates the charging memory of the lithium battery.

6.2.2.2 Charging

(1) Charging method I: Remove the battery box and charge the battery off board. Battery must be in the "ON" position for proper charging.

(2) Charging method II: Charge at the tiller port on the control panel. If charging from the front port, the unit must be switched "OFF", and the battery must be "ON" for proper charging.

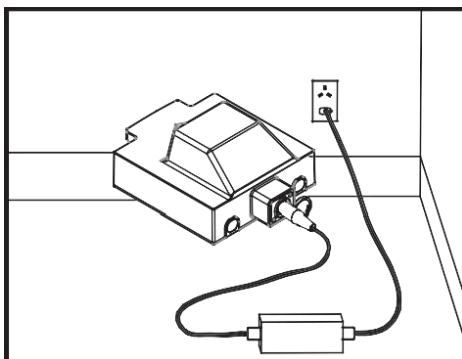

(Charging method I)

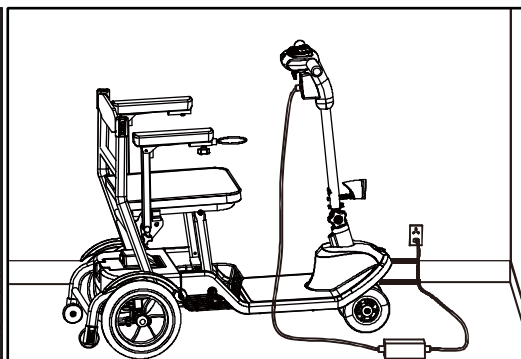

(Charging method II)

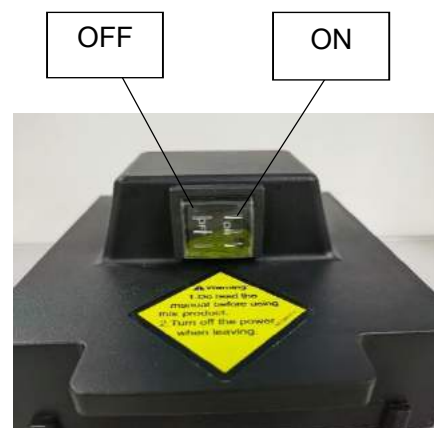



Caution! When charging, the switch on the battery box should be in ON position; that is, charging is performed when the power is turned on.

 **Caution!** To determine whether the lithium battery is fully charged, check the charging indicator on the charger. To know more about the charger indicator, refer to section “6.3 Charger.”

The LED with charging bar does not prove that the battery is fully charged, it should be subject to the charger indicator turning green.

 **Caution!** To ensure safety, do not charge battery near fire, and do not smoke nearby.

 **Caution!** Do not touch the plug with wet hands, and do not charge with a wet plug.

 **Caution!** When charging, avoid rain, dew, and direct sunlight. It is best to charge in a well-ventilated place.

6.3 Charger

Charger model: HP060WL2

Charger input: 100~240V AC,50/60hz,1.2~0.5A

Charger output: 24V, 2A MAX(1.8A)

There are two positions for the charger indicator:

1. Orange indicator: the power is on and charging.
2. Green indicator: Fully charged.

Please note that the scooter should have safe circuits to prevent driving while charging. If the scooter does not drive normally after charging, please check to see whether the battery charger is disconnected from the charging terminal.

The charger must be kept in a dry environment at temperatures 14°F~104°F and should not have any mechanical damage. In all cases, the charger should be repaired only by an authorized dealer or the manufacturer.

 **Caution!**

1. You can only use our original charger. Using other chargers will affect the scooter warranty. Using an unapproved charger can cause serious damage to the battery or the scooter. Using an unsuitable charger can even create a fire hazard.
2. The input voltage of the charger is only limited to the standard public electrical, or common standard supply voltage.

DO NOT USE a power frequency voltage higher than the standard public electrical, or common standard supply voltage.

3. DO NOT USE the charger in instances of high tide and high heat.

4. The charger has its automatic protection function, and no special care is required when charging. When the battery is fully charged, the charger will automatically stop charging, and there is no need to unplug the charger. However, the charger is not allowed to be connected to the scooter for a long time, generally no more than 20 hours.

5. When the charger is overheated (higher than 158°F), sparks, smoke, etc., could result, and the power of the charger should be cut off quickly.

7. Maintenance

7.1 Cleaning the scooter

7.1.1 Seat cushions and backrest covers can be washed with water and neutral detergent once a week.

7.1.2 Other painted parts can be wiped with a cleaning cloth or a disinfecting cloth once a week.

7.2 Disinfecting the scooter

7.2.1 Disinfecting of handles and armrests can be done with a cleaning cloth or a disinfecting cloth dipped in 75% medical alcohol. Then dry them immediately. Once a week disinfecting is sufficient.

 **WARNING!** Risk of injury: Disinfecting should be performed only by trained personnel.

Caution!

 Do not use high pressure cleaners to clean the scooter. Do not splash water on the scooter.

(2) Do not use volatile chemical solvents such as high-concentration alcohol, ether, high-concentration acid or banana water, gasoline, kerosene, etc. Also do not use abrasive waxes, sponges, brushes, etc.

(3) Be sure to turn off the power during cleaning, disinfection and Maintenance 29 maintenance.

(4) All parts must be thoroughly dry before use after cleaning and disinfection.

7.3 Instructions for reuse

7.3.1 Maintenance points

Please review the following before each reuse:

- (1) Check the battery status: Charge the battery
- (2) Wheels/tires condition. Make sure there are no wires, hair, sands and carpet fibers under the tires. If tires are visibly worn, contact your specialist dealer for replacement.
- (3) Check the control panel and cables for damage such as frayed, broken, or exposed wires.
- (4) Check that the filler is tightened.
- (5) Check the seat and back for dents, damage, or tears. Replace them if necessary.
- (6) When needed, contact your specialist dealer for repairs or parts replacement.

Have your mobility scooter inspected and maintained at least once a year or more frequently. The minimum maintenance frequency depends on usage and should be agreed upon by you and your dealer.

Make sure your scooter is stored dry to prevent mildew growth and damage to the upholstery. If your scooter is stored for a longer period of time, you will still need to charge the battery weekly.

7.4 Inspection, service and maintenance

7.4.1 Daily inspection

- (1) Check whether the throttle control lever is deformed or damaged.
- (2) After turning on the power switch, check if the scooter needs to be charged.
- (3) Check that the brakes are working before driving.

7.4.2 Weekly inspection

- (1) Before checking, please confirm that the power is turned off.
- (2) Check whether the throttle control lever is detached or broken.
- (3) Wipe the scooter with a soft, damp cloth that has been wrung out, taking care not to wet the electrical system.
- (4) Check that the throttle control lever can return to the center point after releasing the lever.

7.4.3 Monthly inspection

- (1) Check the battery condition and wipe the battery connector if necessary.
- (2) Check the electrical system and make sure the connectors are in good contact.
- (3) Check whether the fasteners are loose.
- (4) Check whether the front and rear tires are shaken [IS THAT THE RIGHT WORD?] or cracked or worn.
- (5) Check that the throttle control lever can return to the center point, after releasing the lever.

7.4.4 Annual inspection: Ask a technician at the dealership to do a thorough inspection of your scooter.

7.5 Reuse after a hiatus

To reuse after a long period of inactivity, please first clean, disinfect and maintain the scooter according to sections "7.1, 7.2 and 7.3". Inspect motors, batteries and chargers. Please check that there is no abnormality in the motor or the battery and charger.

7.6 End-of-use disposal



The symbol means that your product should be disposed of separately from household waste according to the local law and regulations. At the end of the scooter's life, take it to the designated recycling place. Sorting and recycling will help conserve natural resources, and ensure it is recycled in an environmentally friendly way. Recycling of each part should be handled by a designated authorized recycling organization in accordance with local laws and regulations. As for plastic parts, frame and pipe parts, they can be handed over to professional recycling units for disposal after the end of use.

8. Transportation and storage

8.1 Transportation and storage

- a) Ambient temperature range: -13°F—104°F;
- b) Relative humidity: ≤80%;
- c) Atmospheric pressure range: 80kPa~105kPa;
- d) Can be transported in general transportation.

9. Common faults and treatment

9.1 Basic Troubleshooting

This table is only a guide to aid you in getting your scooter operating, should you have any problems. If you are unable to get your scooter operating, please contact your scooter dealer.

Symptom	Concern	Solution
Scooter does not move	<ul style="list-style-type: none"> 1. Key switch is not "ON" 2. Main circuit breaker tripped 3. Brake release lever in "Freewheel Mode" 4. Charger connected to outlet 5. Battery power low 6. Scooter shuts down to conserve battery 7. Controller error 	<ul style="list-style-type: none"> 1. Turn the keyswitch to "ON" 2. Reset circuit breaker 3. Place lever in "Drive Mode" 4. Disconnect charger 5. Recharge battery 6. Turn the key switch "OFF," then "ON" 7. Check Power light for Flash Code (See Flash Codes to get a solution)
Range less than expected	<ul style="list-style-type: none"> 1. Charging too infrequently 2. Defective or worn-out battery 3. Cold weather reduces battery life 4. Defective charger 	<ul style="list-style-type: none"> 1. Charge scooter more often 2. Load test batteries and, if necessary, replace. 3. Allow batteries to reach room temperature and then fully recharge 4. Contact your scooter dealer

9.2 Scooter Controller Internal Diagnostics

Flash Code	Flash Indication	Concern	Effect on the Scooter	Solution
1-5	* *****	Battery charge is too low or there is a bad connection	Scooter stops driving	<ol style="list-style-type: none"> 1. Charge batteries. 2. Check all battery wiring connections. 3. Contact your service agent.
3-2	*** **	Brake error	Scooter stops driving	<ol style="list-style-type: none"> 1. Make sure that the freewheel lever is in the drive position and then restart the scooter. 2. There is a concern with the magnetic brake or wiring. 3. Contact your service agent.
1-2	* **	Throttle Pot error (open circuit)	Scooter stops driving	<ol style="list-style-type: none"> 1. The Throttle Pot or its wiring could be faulty. 2. The Speed Pot or its wiring could be faulty. 3. Contact your service agent.
2-5	** *****	Throttle Pot error (short circuit)	Scooter stops driving	<ol style="list-style-type: none"> 1. The Throttle Pot or its wiring could be faulty. 2. The Speed Pot or its wiring could be faulty. 3. Contact your service agent.
1-6	* *****	Throttle control lever not at center position when switching on scooter	Scooter stops driving	<ol style="list-style-type: none"> 1. Put the throttle control lever in the central position, turn the power off and then turn on again. 2. Check that the charger is not connected.
1-3	* ***	Charge inhibited		<ol style="list-style-type: none"> 1. Check the charger and charging socket. 2. Contact your service agent.
1-4	* *****	Internal motor sensor error	Scooter stops driving	<ol style="list-style-type: none"> 1. Check the motor connections and current draw. 2. Contact your scooter dealer.
2-4	** *****	Controller error	Scooter stops driving	<ol style="list-style-type: none"> 1. Check all wiring connections including main battery connections. 2. The controller needs replacing. 3. Contact your service agent.

10. Warranty

10.1 So Lite™ S1 12-Month Limited Warranty

Journey Health and Lifestyle warrants the frame and mechanical components to be free from defects in materials and workmanship for a period of twelve (12) months from the original purchase date. The originally supplied tires and fabric seat are all warranted to be free from defects in materials and workmanship for a period of six (6) months from the original purchase date. If within such warranty period the components or parts referenced in this paragraph shall be proven to Journey Health and Lifestyle's satisfaction to be defective, the product shall, at Journey Health and Lifestyle's option, be repaired or replaced with new or refurbished product components. In some cases, an installation kit with instructions may be provided to the owner to facilitate installation of a replacement product component. This warranty does not include any labor charges incurred in product component installation. The warranty period of the repaired or replaced product shall terminate with the termination of the warranty period for the original product. Journey Health and Lifestyle's sole obligation and your exclusive remedy under this warranty shall be limited to such repaired or replaced product.

Contact Journey Health and Lifestyle before sending any product for warranty repair or replacement. Do not send any product without our prior written consent.

10.2 Limitations and Exclusions:

This warranty does not cover damage, deterioration or malfunction resulting from accident, negligence, misuse, abuse, occupancy by more than one user and cargo weight above that specified in this Product Manual; improper storage; improper operation or failure to follow instructions according to this Product Manual; damage in shipment of the product (claims must be presented to the carrier); repair, attempted repair or modifications made by anyone other than Journey Health and Lifestyle; any unit on which the serial number has been defaced, modified or removed; normal wear items; any periodic maintenance; deterioration due to perspiration, corrosive atmosphere, or ground covering such as pine needles or crushed limestone dust, or other external causes such as punctures, extremes in temperature or humidity; damages related to lighting, flood or circumstances beyond Journey Health and Lifestyle's control; or products subjected to commercial or institution use.

This warranty applies in North America only and is extended only to the original purchaser of the So Lite™ S1 product when purchased directly from Journey Health and Lifestyle (USA) or an authorized reseller. The warranty is nontransferable beyond the initial purchaser. This warranty gives you specific legal rights and you may also have other legal rights which vary from place to place.

The foregoing warranty is exclusive and in lieu of all other express warranties, implied warranties, including but not limited to the implied warranties of merchantability and fitness for a particular purpose, and shall not extend beyond the duration of the express warranty provided herein. Journey Health and Lifestyle shall not be liable for any consequential or incidental damages whatsoever and disclaims any liability beyond the initial purchase price of the So Lite™ S1 product.

Copyright © 2021 Journey Health and Lifestyle

If you have any questions, call us at our toll-free number:

1-800-958-8324



 **journey**[™]
HEALTH & LIFESTYLE

journey
solite
scooter

If you have any questions, call us at our toll free number:

1-800-958-8324